

# The Garador Range Price List

**1st April 2021**

Garage Doors, Front Entrance Doors and Automatic Operators



# General Information

All prices are quoted in £ Sterling, ex-works and exclusive of VAT.

Please ensure that you order the correct size door to fit your opening as we are unable to accept the return of incorrectly ordered goods. Please contact Garador on 01935 443722 if you need assistance in calculating the correct size.

A comprehensive range of the less common accessories and all spare parts are available either online or ask for a current spares price list if required.

Since the company's policy is one of continuous improvement of its products, we reserve the right to make any alterations in design, manufacture or price.

All business is governed by the Company's Standard Conditions and this document does not form any part of any contract with the company and statements contained in it should not be construed as representations or warranties.

For more information please visit  
[www.garador.co.uk](http://www.garador.co.uk)



# Contents

Steel Panel Doors	4
Guardian Range	14
Design Range	16
GRP Premier Panel Doors	18
Timber Panel Doors	24
Steel and Timber Garage Side Doors	34
Steel, Timber and GRP Side-hinged Doors	36
Steel Panel Doors - Specifications	42
Steel Sectional Garage Doors	48
Automation and Accessories	64
GaraRoll Roller Doors	70
GaraGlide Roller Doors	74
FrontGuard 46 and FrontGuard 65 Entrance Doors	80
User Information / Care	94
Warranty	96
Extracts from DHF consumer advice	98

# Steel Panel Doors

## Surface

High quality powder or foil coated finish.

Please note: panel doors are produced with appearance in mind. This may result in some small gaps which could allow water ingress especially in exposed locations.

## Colours

All doors supplied in Traffic White (RAL 9016) as standard.

Optional colours available on an approximate 4 week lead-time:

- Light Ivory (RAL 1015)	- Pigeon Blue (RAL 5014)	- Anthracite Grey (RAL 7016)	- Burgundy Brown
- Ruby Red (RAL 3003)	- Moss Green (RAL 6005)	- Terra Brown (RAL 8028)	- Golden Brown
- Signal Blue (RAL 5005)	- Fir Green (RAL 6009)	- Jet Black (RAL 9005)	- Chartwell Green (BS 4800)
- Steel Blue (RAL 5011)	- Slate Grey (RAL 7015)		

Other optional colours available on an approximate 6 week lead-time:

- Stone Grey (RAL 7030)	- Light grey (RAL 7035)	- Window Grey (RAL 7040)	- Clay Brown (RAL 8003)
-------------------------	-------------------------	--------------------------	-------------------------

Timber effect finishes are available in either a Golden Oak or Rosewood foil coat timber effect.

## Handle

Black handle as standard, optional handles are available. Doors can be supplied undrilled and without handle and locking mechanism for use with electric operator (not available on Wentwood or Sherwood doors). This option makes the door purpose made and will therefore increase lead-time, please specify clearly on order.

## Terminology

Nominal Door Size: This is the actual door panel size plus the fitting tolerances. The nominal door size should be used for internal dimensions of a timber frame.

Size Code: This has traditionally been used to order doors. This may not be the actual door size.

## Packaging

White and brown doors are supplied unwrapped as standard with optional poly-wrapping available. Coloured doors are supplied wrapped and - also - include a touch up stick as standard. Side-hinged doors are provided wrapped as standard.

## Stock availability

Prices in bold show stock doors in Traffic White (unless specified) and all other prices relate to non-stock doors.



### Canopy gearing (shown as C)

Canopy gear is available for all single doors providing a reliable and affordable gearing solution, with no tracks running back into the garage.

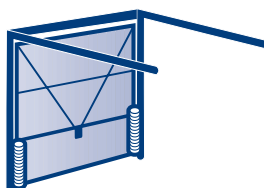

### Retractable gearing (shown as R)

Retractable gear is available for all single and double doors providing a reliable and affordable gearing solution, with tracks running back into the garage.

Single door

Nominal Door Size  
Width x Height  
(mm x mm)

Size  
Code

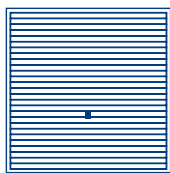

Horizon

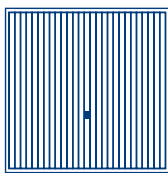

Carlton

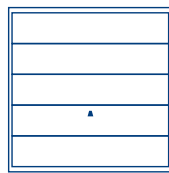

Ascot

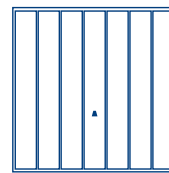

Windsor

	Size Code	Horizon		Carlton		Ascot		Windsor	
		C	R	C	R	C	R	C	R
1984 x 1830	6660	627	676	711	760	-	-	-	-
1984 x 1905	6663	627	676	711	760	-	-	-	-
1984 x 1931	6664	<b>627</b>	<b>676</b>	711	760	-	-	-	-
1984 x 1981	6666	<b>594</b>	<b>643</b>	675	724	-	-	-	-
1984 x 2136	6670	<b>594</b>	<b>643</b>	675	724	-	-	-	-
2084 x 1931	61064	<b>605</b>	<b>654</b>	674	723	-	-	-	-
2084 x 1981	61066	<b>621</b>	<b>670</b>	<b>674</b>	<b>723</b>	-	-	-	-
2084 x 2136	61070	<b>643</b>	<b>692</b>	<b>690</b>	<b>739</b>	-	-	-	-
2134 x 1830	7060	<b>644</b>	<b>693</b>	729	778	-	-	-	-
2134 x 1905	7063	<b>644</b>	<b>693</b>	729	778	-	-	-	-
2134 x 1931	7064	<b>613</b>	<b>662</b>	<b>679</b>	<b>728</b>	-	-	-	-
2134 x 1981	7066	<b>568</b> <sup>2</sup>	<b>617</b> <sup>2</sup>	<b>656</b> <sup>2</sup>	<b>705</b>	<b>692</b>	<b>741</b>	<b>809</b>	<b>858</b>
2134 x 2036	7068	648	697	717	766	-	-	-	-
2134 x 2136	7070	<b>622</b> <sup>2</sup>	<b>671</b> <sup>2</sup>	<b>683</b> <sup>2</sup>	<b>732</b>	<b>773</b>	<b>822</b>	<b>835</b>	<b>884</b>
2134 x 2186	7072	-	706	-	770	-	-	-	-
2134 x 2286	7076	-	792	-	848	-	-	-	-
2170 x 1905	7163	613	662	679	728	-	-	-	-
2170 x 1931	7164	<b>613</b>	<b>662</b>	679	728	-	-	-	-
2170 x 1981	7166	<b>568</b>	<b>617</b>	<b>656</b>	<b>705</b>	692	741	809	858
2170 x 2036	7168	648	697	717	766	-	-	-	-
2170 x 2136	7170	<b>622</b>	<b>671</b>	<b>683</b>	<b>732</b>	773	822	835	884
2170 x 2186	7172	-	706	-	770	-	-	-	-
2170 x 2286	7176	-	876	-	922	-	-	-	-
2224 x 1905	7363	667	716	710	759	-	-	-	-
2224 x 1931	7364	<b>667</b>	<b>716</b>	710	759	-	-	-	-
2224 x 1981	7366	<b>670</b>	<b>719</b>	714	763	-	-	-	-
2224 x 2136	7370	680	729	722	771	-	-	-	-
2259 x 1905	7563	661	710	717	766	-	-	-	-
2259 x 1931	7564	<b>661</b>	<b>710</b>	717	766	-	-	-	-
2259 x 1981	7566	<b>667</b>	<b>716</b>	<b>717</b>	<b>766</b>	793	842	865	914
2259 x 2036	7568	698	747	757	806	-	-	-	-
2259 x 2136	7570	<b>759</b>	<b>808</b>	<b>808</b>	<b>857</b>	900	949	936	985
2259 x 2186	7572	-	851	-	870	-	-	-	-
2259 x 2286	7576	-	943	-	922	-	-	-	-
2284 x 1905	7663	667	716	737	786	-	-	-	-
2284 x 1931	7664	<b>667</b>	<b>716</b>	737	786	-	-	-	-
2284 x 1981	7666	<b>667</b>	<b>716</b>	<b>737</b>	<b>786</b>	793	842	865	914
2284 x 2036	7668	705	754	778	827	-	-	-	-
2284 x 2136	7670	<b>761</b>	<b>810</b>	<b>808</b> <sup>1</sup>	<b>857</b> <sup>1</sup>	888	937	936	985
2284 x 2186	7672	-	853	-	902	-	-	-	-
2284 x 2286	7676	-	947	-	922	-	-	-	-
2439 x 1905	8063	770	819	872	921	-	-	-	-
2439 x 1931	8064	<b>770</b>	<b>819</b>	872	921	-	-	-	-
2439 x 1981	8066	<b>770</b>	<b>819</b>	<b>872</b>	<b>921</b>	881	930	1003	1052
2439 x 2036	8068	813	862	920	969	-	-	-	-
2439 x 2136	8070	<b>786</b>	<b>835</b>	<b>901</b> <sup>1</sup>	<b>950</b>	911	960	1033	1082
2439 x 2186	8072	-	879	-	1001	-	-	-	-
2439 x 2286	8076	-	923	-	1004	-	-	-	-
2590 x 1981	8666	-	888	-	1001	-	-	-	-
2590 x 2136	8670	-	920	-	1042	-	-	-	-
2590 x 2286	8676	-	1014	-	1133	-	-	-	-
2744 x 1981	9066	-	1061	-	1075	-	-	-	-
2744 x 2136	9070	-	1116	-	1133	-	-	-	-
2744 x 2286	9076	-	1159	-	1176	-	-	-	-
3049 x 1981	1066	-	1253	-	1208	-	-	-	-
3049 x 2136	1070	-	1267	-	1222	-	-	-	-

Stock doors also available in Jet Black (based on RAL 9005).

<sup>1</sup> Stock doors also available in Anthracite Grey (RAL 7016)

<sup>2</sup> Stock doors available in Jet Black (RAL 9005) or Anthracite Grey (RAL 7016).

For further options please see page 13.

Single door

Nominal Door Size  
Width x Height  
(mm x mm)      Size  
Code

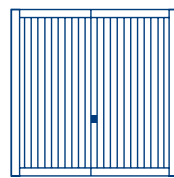

Sutton

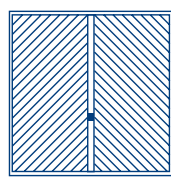

Chevron

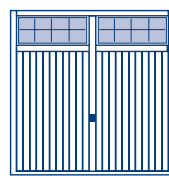

Salisbury <sup>1</sup>



Wentwood  
Timber Effect

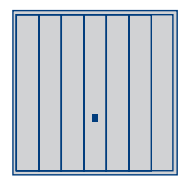

Sherwood  
Timber Effect

	Size Code	Sutton		Chevron		Salisbury <sup>1</sup>		Wentwood Timber Effect		Sherwood Timber Effect	
		C	R	C	R	C	R	C	R	C	R
1984 x 1830	6660	-	-	-	-	-	-	-	-	-	-
1984 x 1905	6663	-	-	-	-	-	-	-	-	-	-
1984 x 1931	6664	-	-	-	-	-	-	-	-	-	-
1984 x 1981	6666	-	-	-	-	-	-	-	-	-	-
1984 x 2136	6670	-	-	-	-	-	-	-	-	-	-
2084 x 1931	61064	-	-	-	-	-	-	-	-	-	-
2084 x 1981	61066	-	-	-	-	-	-	-	-	-	-
2084 x 2136	61070	-	-	-	-	-	-	-	-	-	-
2134 x 1830	7060	-	-	-	-	-	-	-	-	-	-
2134 x 1905	7063	-	-	-	-	-	-	-	-	-	-
2134 x 1931	7064	741	790	741	790	1129	1178	-	-	-	-
2134 x 1981	7066	702	751	702	751	<b>1129</b>	<b>1178</b>	<b>730</b>	<b>779</b>	<b>847</b>	<b>896</b>
2134 x 2136	7070	<b>749</b>	<b>798</b>	<b>749</b>	<b>798</b>	<b>1142</b>	<b>1191</b>	<b>811</b>	<b>860</b>	<b>872</b>	<b>921</b>
2134 x 2286	7076	-	-	-	-	-	-	-	-	-	-
2170 x 1931	7164	-	-	-	-	-	-	-	-	-	-
2170 x 1981	7166	-	-	-	-	-	-	-	-	-	-
2170 x 2136	7170	-	-	-	-	-	-	-	-	-	-
2170 x 2286	7176	-	-	-	-	-	-	-	-	-	-
2224 x 1931	7364	-	-	-	-	-	-	-	-	-	-
2224 x 1981	7366	-	-	-	-	-	-	-	-	-	-
2224 x 2136	7370	-	-	-	-	-	-	-	-	-	-
2259 x 1931	7564	814	863	814	863	1174	1223	-	-	-	-
2259 x 1981	7566	814	863	814	863	1174	1223	<b>831</b>	<b>880</b>	<b>902</b>	<b>951</b>
2259 x 2136	7570	896	945	896	945	1185	1234	<b>925</b>	<b>974</b>	<b>975</b>	<b>1024</b>
2259 x 2286	7576	-	-	-	-	-	-	-	-	-	-
2284 x 1931	7664	822	871	822	871	1174	1223	-	-	-	-
2284 x 1981	7666	781	830	781	830	1174	1223	<b>831</b>	<b>880</b>	<b>902</b>	<b>951</b>
2284 x 2136	7670	862	911	862	911	<b>1185</b>	<b>1234</b>	<b>925</b>	<b>974</b>	<b>975</b>	<b>1024</b>
2284 x 2286	7676	-	-	-	-	-	-	-	-	-	-
2439 x 1931	8064	906	955	-	-	1246	1295	-	-	-	-
2439 x 1981	8066	906	955	-	-	1246	1295	<b>919</b>	<b>968</b>	<b>1040</b>	<b>1089</b>
2439 x 2136	8070	922	971	-	-	<b>1257</b>	<b>1306</b>	<b>952</b>	<b>1001</b>	<b>1072</b>	<b>1121</b>
2439 x 2286	8076	-	-	-	-	-	-	-	-	-	-
2590 x 1981	8666	-	-	-	-	-	-	-	-	-	-
2590 x 2136	8670	-	-	-	-	-	-	-	-	-	-
2590 x 2286	8676	-	-	-	-	-	-	-	-	-	-
2744 x 1981	9066	-	-	-	-	-	-	-	-	-	-
2744 x 2136	9070	-	-	-	-	-	-	-	-	-	-
2744 x 2286	9076	-	-	-	-	-	-	-	-	-	-
3049 x 1981	1066	-	-	-	-	-	-	-	-	-	-
3049 x 2136	1070	-	-	-	-	-	-	-	-	-	-

<sup>1</sup> Salisbury windows (with window icon) come as white or brown as standard, colour match windows are available to order as an option, see page 13.

<sup>2</sup> Also available on 1 week lead time in Jet Black (RAL 9005) with black colour match windows.

Please note that doors with windows may have cross bracing or locking rods passing behind the windows depending upon size and gear type.

Stock doors also available in Jet Black (based on RAL 9005).

Wentwood and Sherwood models are only available in either a Golden Oak or Rosewood foil coat timber effect finish.

For further options please see page 13.

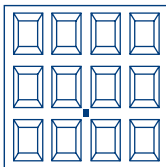
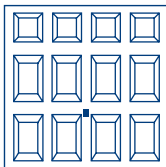
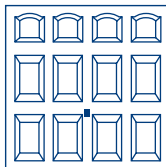
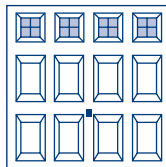
Single door									
Nominal Door Size Width x Height (mm x mm)	Size Code	Georgian		Beaumont		Cathedral		Beaumont with Windows <sup>1</sup>	
		C	R	C	R	C	R	C	R
1984 x 1830	6660	-	-	-	-	-	-	-	-
1984 x 1905	6663	-	-	-	-	-	-	-	-
1984 x 1931	6664	<b>869</b>	<b>918</b>	869	918	869	918	1183	1232
1984 x 1981	6666	823	872	823	872	<b>823</b>	<b>872</b>	<b>1189</b>	<b>1238</b>
1984 x 2136	6670	836	885	836	885	836	885	1150	1199
2084 x 1931	61064	833	882	833	882	833	882	1146	1195
2084 x 1981	61066	834	883	834	883	<b>834</b>	<b>883</b>	1148	1197
2084 x 2136	61070	895	944	895	944	<b>895</b>	<b>944</b>	1207	1256
2134 x 1830	7060	-	-	-	-	-	-	-	-
2134 x 1905	7063	-	-	-	-	-	-	-	-
2134 x 1931	7064	834	883	834	883	834	883	1148	1197
2134 x 1981	7066	<b>834</b>	<b>883</b>	<b>834</b>	<b>883</b>	<b>834</b>	<b>883</b>	<b>1148</b>	<b>1197</b>
2134 x 2136	7070	<b>883</b>	<b>932</b>	<b>883</b>	<b>932</b>	<b>883</b>	<b>932</b>	<b>1196</b>	<b>1245</b>
2134 x 2286	7076	-	1051	-	1051	-	1051	-	1364
2170 x 1931	7164	834	883	834	883	834	883	1148	1197
2170 x 1981	7166	834	883	834	883	834	883	1148	1197
2170 x 2136	7170	883	932	883	932	883	932	1196	1245
2170 x 2286	7176	-	1137	-	1137	-	1137	-	1451
2224 x 1931	7364	927	976	927	976	927	976	1243	1292
2224 x 1981	7366	932	981	932	981	932	981	1247	1296
2224 x 2136	7370	938	987	938	987	938	987	1253	1302
2259 x 1931	7564	927	976	927	976	927	976	1243	1292
2259 x 1981	7566	<b>927</b>	<b>976</b>	927	976	927	976	1243	1292
2259 x 2136	7570	1067	1116	1067	1116	1067	1116	1384	1433
2259 x 2286	7576	-	1296	-	1296	-	1296	-	1609
2284 x 1931	7664	927	976	927	976	927	976	1243	1292
2284 x 1981	7666	<b>927</b>	<b>976</b>	927	976	<b>927</b>	<b>976</b>	1243	1292
2284 x 2136	7670	<b>1067</b>	<b>1116</b>	1067	1116	<b>1067</b>	<b>1116</b>	<b>1384</b>	<b>1433</b>
2284 x 2286	7676	-	1296	-	1296	-	1296	-	1609
2439 x 1931	8064	1098	1147	1098	1147	1098	1147	1412	1461
2439 x 1981	8066	<b>1098</b>	<b>1147</b>	1098	1147	1098	1147	1412	1461
2439 x 2136	8070	1143	1192	1143	1192	1143	1192	<b>1458</b>	<b>1507</b>
2439 x 2286	8076	-	1271	-	1271	-	1271	-	1636
2590 x 1981	8666	-	1171	-	1171	-	1171	-	1534
2590 x 2136	8670	-	<b>1184</b>	-	1184	-	1184	-	1549
2590 x 2286	8676	-	1312	-	1312	-	1312	-	1675
2744 x 1981	9066	-	1189	-	1189	-	1189	-	1554
2744 x 2136	9070	-	1203	-	1203	-	1203	-	1567
2744 x 2286	9076	-	1331	-	1331	-	1331	-	1696
3049 x 1981	1066	-	1234	-	1234	-	1234	-	1600
3049 x 2136	1070	-	1259	-	1259	-	1259	-	1626

<sup>1</sup> Windows for Beaumont: Standard () , Diamond () , Cross (). Please state on order if clear or crystal panes, see page 13.

Please note that doors with windows may have cross bracing or locking rods passing behind the windows depending upon size and gear type.

 Stock doors also available in Jet Black (based on RAL 9005).

For further options please see page 13.

Single door

Nominal Door Size  
Width x Height  
(mm x mm)

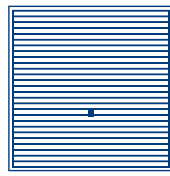

Horizon

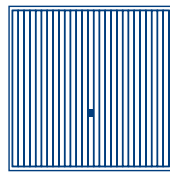

Carlton

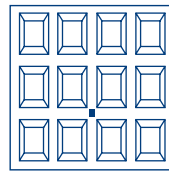

Georgian

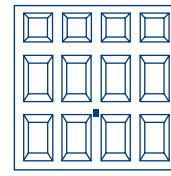

Beaumont

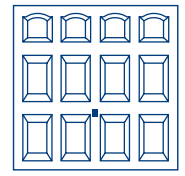

Cathedral

		Horizon		Carlton		Georgian		Beaumont		Cathedral	
		C	R	C	R	C	R	C	R	C	R
1830-1930	x 1830-1930	827	876	859	908	-	-	-	-	-	-
1830-1930	x 1931-1981	858	907	891	940	-	-	-	-	-	-
1830-1930	x 1982-2136	923	972	942	991	-	-	-	-	-	-
1830-1930	x 2137-2286	-	1039	-	1074	-	-	-	-	-	-
1830-1930	x 2287-2439	-	1114	-	1143	-	-	-	-	-	-
1931-1984	x 1830-1930	833	882	869	918	-	-	-	-	-	-
1931-1984	x 1931-1981	864	913	898	947	-	-	-	-	-	-
1931-1984	x 1982-2136	917	966	947	996	-	-	-	-	-	-
1931-1984	x 2137-2286	-	1039	-	1074	-	-	-	-	-	-
1931-1984	x 2287-2439	-	1114	-	1143	-	-	-	-	-	-
1985-2134	x 1830-1930	864	913	897	946	-	-	-	-	-	-
1985-2134	x 1931-1981	917	966	947	996	1304	1353	1304	1353	1304	1353
1985-2134	x 1982-2136	989	1038	1009	1058	1385	1434	1385	1434	1385	1434
1985-2134	x 2137-2286	-	1114	-	1143	-	1521	-	1521	-	1521
1985-2134	x 2287-2439	-	1184	-	1205	-	1467	-	1467	-	1467
2135-2284	x 1830-1930	917	966	935	984	-	-	-	-	-	-
2135-2284	x 1931-1981	989	1038	1009	1058	1397	1446	1397	1446	1397	1446
2135-2284	x 1982-2136	1051	1100	1085	1134	1397	1446	1397	1446	1397	1446
2135-2284	x 2137-2286	-	1184	-	1205	-	1508	-	1508	-	1508
2135-2284	x 2287-2439	-	1258	-	1289	-	1716	-	1716	-	1716
2285-2499 <sup>1</sup>	x 1830-1930	989	1038	1020	1069	-	-	-	-	-	-
2285-2499 <sup>1</sup>	x 1931-1981	1051	1100	1085	1134	1481	1530	1481	1530	1481	1530
2285-2499 <sup>1</sup>	x 1982-2136	1060	1109	1143	1192	1507	1556	1507	1556	1507	1556
2285-2499	x 2137-2286	-	1208	-	1234	-	1603	-	1603	-	1603
2285-2499	x 2287-2439	-	1259	-	1272	-	1668	-	1668	-	1668
2500-2590	x 1830-1930	-	1133	-	1153	-	-	-	-	-	-
2500-2590	x 1931-1981	-	1184	-	1205	-	1590	-	1590	-	1590
2500-2590	x 1982-2136	-	1259	-	1259	-	1615	-	1615	-	1615
2500-2590	x 2137-2286	-	1272	-	1272	-	1653	-	1653	-	1653
2500-2590	x 2287-2439	-	1349	-	1349	-	1706	-	1706	-	1706
2591-2722	x 1830-1930	-	1203	-	1203	-	-	-	-	-	-
2591-2722	x 1931-1981	-	1253	-	1253	-	1597	-	1597	-	1597
2591-2722	x 1982-2136	-	1340	-	1340	-	1673	-	1673	-	1673
2591-2722	x 2137-2286	-	1423	-	1423	-	1723	-	1723	-	1723
2591-2722	x 2287-2439	-	1519	-	1519	-	-	-	-	-	-
2723-3049	x 1830-1930	-	-	-	1465	-	-	-	-	-	-
2723-3049	x 1931-1981	-	-	-	1518	-	1706	-	1706	-	1706
2723-3049	x 1982-2136	-	-	-	1672	-	1770	-	1770	-	1770

<sup>1</sup> Canopy gear only available up to 2439 wide.

Orders for purpose made sizes will only be accepted as nominal door size for unframed version and overall frame size when ordering a framed version. Orders for purpose made framed doors will not be accepted as nominal door size.

For further options please see page 13.



## Single door

Nominal Door Size  
Width x Height  
(mm x mm)

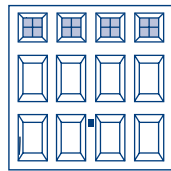

Beaumont with  
Windows<sup>2</sup>

		C	R
1830-1930	x 1830-1930	-	-
1830-1930	x 1931-1981	-	-
1830-1930	x 1982-2136	-	-
1830-1930	x 2137-2286	-	-
1830-1930	x 2287-2439	-	-
1931-1984	x 1830-1930	-	-
1931-1984	x 1931-1981	-	-
1931-1984	x 1982-2136	-	-
1931-1984	x 2137-2286	-	-
1931-1984	x 2287-2439	-	-
1985-2134	x 1830-1930	-	-
1985-2134	x 1931-1981	1618	1667
1985-2134	x 1982-2136	1700	1749
1985-2134	x 2137-2286	-	1836
1985-2134	x 2287-2439	-	1781
2135-2284	x 1830-1930	-	-
2135-2284	x 1931-1981	1713	1762
2135-2284	x 1982-2136	1713	1762
2135-2284	x 2137-2286	-	1823
2135-2284	x 2287-2439	-	2030
2285-2499 <sup>1</sup>	x 1830-1930	-	-
2285-2499 <sup>1</sup>	x 1931-1981	1798	1847
2285-2499 <sup>1</sup>	x 1982-2136	1822	1871
2285-2499	x 2137-2286	-	1918
2285-2499	x 2287-2439	-	1983
2500-2590	x 1830-1930	-	-
2500-2590	x 1931-1981	-	1905
2500-2590	x 1982-2136	-	1931
2500-2590	x 2137-2286	-	1968
2500-2590	x 2287-2439	-	2019
2591-2722	x 1830-1930	-	-
2591-2722	x 1931-1981	-	1911
2591-2722	x 1982-2136	-	1989
2591-2722	x 2137-2286	-	2039
2591-2722	x 2287-2439	-	-
2723-3049	x 1830-1930	-	-
2723-3049	x 1931-1981	-	2019
2723-3049	x 1982-2136	-	2083

<sup>1</sup> Canopy gear only available up to 2439 wide.

<sup>2</sup> Windows for Beaumont: Standard (□), Diamond (◊), Cross (⊠). Please state on order if clear or crystal panes.

Orders for purpose made sizes will only be accepted as nominal door size for unframed version and overall frame size when ordering a framed version. Orders for purpose made framed doors will not be accepted as nominal door size.

Please note that doors with windows may have cross bracing or locking rods passing behind the windows depending upon size and gear type.

For further options please see page 13.

Double door

Nominal Door Size  
Width x Height  
(mm x mm)

Size  
Code

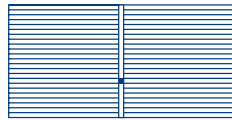

Horizon

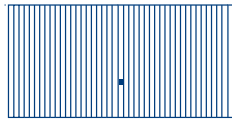

Carlton

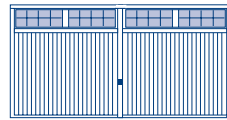

Salisbury

		R	R	R
3049 x 2286	1076	1621	1621	-
3354 x 1981	1166	1518	1518	-
3354 x 2136	1170	1529	1529	-
3354 x 2286	1176	1568	1568	-
3659 x 1981	1266	1593	1593	-
3659 x 2136	1270	1605	1605	-
3659 x 2286	1276	1719	1719	-
3964 x 1981	1366	1734	1734	-
3964 x 2136	1370	1746	1746	-
3964 x 2286	1376	1914	1914	-
4269 x 1981	1466	<b>1670</b>	<b>1670</b>	2313
4269 x 2136	1470	<b>1670</b>	<b>1670</b>	<b>2313</b>
4574 x 1981	1566	1798	1798	-
4574 x 2136	1570	1825	1825	-
4879 x 1981	1666	1902	1902	-
4879 x 2136	1670	1927	1927	-

Double door

Nominal Door Size  
Width x Height  
(mm x mm)

Size  
Code

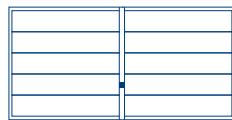

Ascot





Windsor

		R	R
3049 x 2286	1076	-	-
3354 x 1981	1166	-	-
3354 x 2136	1170	-	-
3354 x 2286	1176	-	-
3659 x 1981	1266	-	-
3659 x 2136	1270	-	-
3659 x 2286	1276	-	-
3964 x 1981	1366	-	-
3964 x 2136	1370	-	-
3964 x 2286	1376	-	-
4269 x 1981	1466	1765	1765
4269 x 2136	1470	1765	1765
4574 x 1981	1566	-	-
4574 x 2136	1570	-	-
4879 x 1981	1666	-	-
4879 x 2136	1670	-	-

Please note that doors with windows may have cross bracing or locking rods passing behind the windows depending upon size and gear type.

For further options please see page 13.

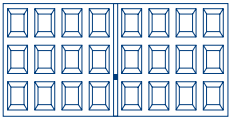
Double door

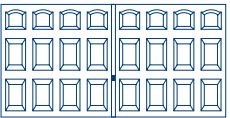
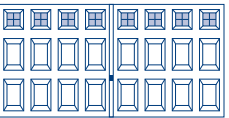
Nominal Door Size Width x Height (mm x mm)	Size Code				
		Georgian	Beaumont	Cathedral	Beaumont with Windows <sup>1</sup>
		R	R	R	R
3049 x 2286	1076	1621	1621	1621	2091
3354 x 1981	1166	1593	1593	1593	2067
3354 x 2136	1170	1593	1593	1593	2067
3354 x 2286	1176	1721	1721	1721	2193
3659 x 1981	1266	1697	1697	1697	2168
3659 x 2136	1270	1697	1697	1697	2168
3659 x 2286	1276	1774	1774	1774	2245
3964 x 1981	1366	1747	1747	1747	2219
3964 x 2136	1370	1747	1747	1747	2219
3964 x 2286	1376	1774	1774	1774	2219
4269 x 1981	1466	1798	1798	1798	2427
4269 x 2136	1470	<b>1798</b>	<b>1798</b>	<b>1798</b>	2427
4574 x 1981	1566	1953	1953	1953	2424
4574 x 2136	1570	1953	1953	1953	2424
4879 x 1981	1666	2055	2055	2055	2529
4879 x 2136	1670	2055	2055	2055	2529

<sup>1</sup> Windows for Beaumont: Standard () , Diamond () , Cross () . Please state on order if clear or crystal panes.

Please note that doors with windows may have cross bracing or locking rods passing behind the windows depending upon size and gear type.

For further options please see page 13.

### Double door

Nominal Door Size  
Width x Height  
(mm x mm)

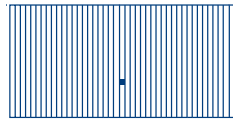

Carlton

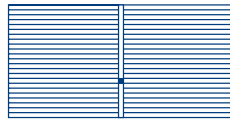

Horizon

	R	R
2745-3049 x 2137-2286	1876	-
3050-3354 x 1886-1981	1774	1798
3050-3354 x 1982-2136	1786	1811
3050-3354 x 2137-2286	1953	1979
3355-3659 x 1886-1981	1825	1850
3355-3659 x 1982-2136	1862	1887
3355-3659 x 2137-2286	1953	1979
3660-3967 x 1886-1981	1991	2017
3660-3967 x 1982-2136	2029	2055
3660-3967 x 2137-2286	2172	2195
3968-4269 x 1886-1981	1927	1953
3968-4269 x 1982-2136	1953	1979
4270-5000 x 1886-1981	2134	2157
4270-5000 x 1982-2136	2183	2210

### Double door

Nominal Door Size  
Width x Height  
(mm x mm)

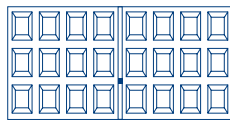

Georgian

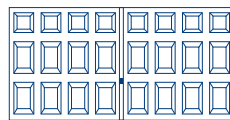

Beaumont

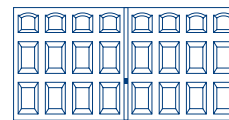

Cathedral

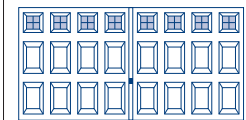

Beaumont with Windows<sup>1</sup>

	R	R	R	R
2745-3049 x 2137-2286	1876	1876	1876	2200
3050-3354 x 1931-1981	1850	1850	1850	2323
3050-3354 x 1982-2136	1876	1876	1876	2348
3050-3354 x 2137-2286	1979	1979	1979	2453
3355-3659 x 1931-1981	1953	1953	1953	2424
3355-3659 x 1982-2136	2004	2004	2004	2477
3355-3659 x 2137-2286	2029	2029	2029	2501
3660-3967 x 1931-1981	2004	2004	2004	2631
3660-3967 x 1982-2136	2029	2029	2029	2658
3660-3967 x 2137-2286	2055	2055	2055	2684
3968-4269 x 1931-1981	2055	2055	2055	2684
3968-4269 x 1982-2136	2055	2055	2055	2684
4270-5000 x 1931-1981	2313	2313	2313	3098
4270-5000 x 1982-2136	2313	2313	2313	3098

<sup>1</sup> Windows for Beaumont: Standard (□), Diamond (◊), Cross (⊞). Please state on order if clear or crystal panes.

Orders for purpose made sizes will only be accepted as nominal door size for unframed version and overall frame size when ordering a framed version. Orders for purpose made framed doors will not be accepted as nominal door size. Please note that doors with windows may have cross bracing or locking rods passing behind the windows depending upon size and gear type. For further options please see page 13.

Options	Single doors	Double doors
	add	add
Factory pre-framed standard single doors	125	-
Steel frame for standard double doors	-	189
Factory pre-framed purpose-made single doors (framed retractable purpose made doors require a 4 week lead-time)	142	-
Steel frame for purpose made double doors	-	210
Additional Lock Kit, C-type/ R-type (fitted onto door)	58	-
Retractable plus gear available on 1931, 1981 and 2136 mm high doors up to 2744 mm wide	39	-
For powder-coated doors <sup>1</sup> : Brown (RAL 8028) <sup>1</sup>	37	71
For powder-coated doors <sup>1</sup> : Moss Green (RAL 6005), Ruby Red (RAL 3003), Signal Blue (RAL 5005), Jet Black (RAL 9005), Steel Blue (RAL 5011), Light Ivory (RAL 1015), Pigeon Blue (RAL 5014), Fir Green (RAL 6009), Anthracite Grey (RAL 7016), Stone Grey (RAL 7030), Light Grey (RAL 7035), Slate Grey (RAL 7015), Clay Brown (RAL 8003), Window Grey (RAL 7040), Chartwell Green (BS 4800), Burgundy Brown <sup>2</sup> and Golden Brown <sup>2</sup> .	123	194
Coloured window frames to match door colour – Beaumont doors (price per window). Beaumont doors up to 3049 wide = 4 windows, between 3050 to 3964 = 6 windows, between 3965 to 4860 = 8 windows and over 4860 = 10 windows <sup>2</sup> .	44 each	44 each
Coloured window frames to match door colour – Salisbury doors (price per door) <sup>2</sup>	155	308
Black window panes for Salisbury doors (price per door)	34	65
Poly-wrapping (available on white and brown)	27	45
Diecast metal handles: brass effect, chrome effect, brushed steel and white	34	34
Bottom weatherseal, 2405 mm length (suitable for gaps up to 15 mm between the door and the floor level)	41	41
Bottom weatherseal, 3000 mm length (suitable for gaps up to 15 mm between the door and the floor level)	46	46
Surcharge on Brown RAL 8028 and White RAL 9016 doors for colour steel frame in RAL colour not matching Garage door	123	194

<sup>1</sup> Please state coloured windows required on order. Coloured Beaumont with windows and Salisbury doors are supplied with white or brown window frames as standard.

<sup>2</sup> Colour match windows not available in Burgundy Brown or Golden Brown.

Please note that doors with windows may have cross bracing or locking rods passing behind the windows depending upon size and gear type.

# Guardian Range

## New Secured By Design certified Up & Over doors

These doors have been tested to the STS 202 Security Technical Specification and achieve Secured By Design accreditation. New lock body protection, anti-snap cylinder, high security bracing and improved lock security make these doors even more secure.

### Information

Guardian Range doors come with a pre-fitted steel frame and cannot be fitted to a custom made timber frame.

There is no mechanism to unlock Guardian range doors from the inside.

Guardian Range doors are not suitable for automation.

Window panes on Secured by Design Salisbury doors are black non-translucent.

## Single door - standard sizes

Nominal Door Size  
Width x Height  
(mm x mm)

Size  
Code

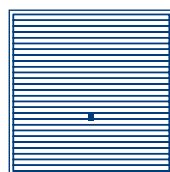

Horizon

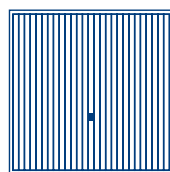

Carlton

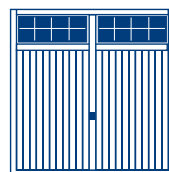

Salisbury

Nominal Door Size Width x Height (mm x mm)	Size Code	Horizon		Carlton		Salisbury	
		C	R	C	R	C	R
1984 x 1830	6660	1058	1107	1144	1193	-	-
1984 x 1905	6663	1058	1107	1144	1193	-	-
1984 x 1931	6664	1058	1107	1144	1193	-	-
1984 x 1981	6666	1027	1076	1110	1159	-	-
1984 x 2136	6670	1039	1088	1110	1159	-	-
2084 x 1931	61064	1039	1088	1110	1159	-	-
2084 x 1981	61066	1053	1102	1110	1159	-	-
2084 x 2136	61070	1075	1124	1121	1170	-	-
2134 x 1830	7060	1077	1126	1162	1211	-	-
2134 x 1905	7063	1077	1126	1162	1211	-	-
2134 x 1931	7064	1044	1093	1112	1161	1563	1612
2134 x 1981	7066	<b>975</b>	<b>1024</b>	1089	<b>1138</b>	1563	1612
2134 x 2031	7068	1103	1152	1174	1223	-	-
2134 x 2136	7070	<b>1054</b>	<b>1103</b>	<b>1117</b>	<b>1166</b>	1575	1624
2134 x 2186	7072	-	1162	-	1229	-	-
2170 x 1931	7164	1103	1152	1158	1207	-	-
2170 x 1981	7166	975	1024	1089	1138	-	-
2170 x 2036	7168	1103	1152	1174	1223	-	-
2170 x 2136	7170	1121	1170	1193	1242	-	-
2170 x 2186	7172	-	1170	-	1242	-	-
2224 x 1931	7364	<b>1099</b>	<b>1148</b>	1143	1192	-	-
2224 x 1981	7366	1103	1152	1146	1195	-	-
2224 x 2136	7370	1113	1162	1155	1204	-	-
2259 x 1931	7564	1134	1183	1181	1230	1606	1655
2259 x 1981	7566	1099	1148	1150	1199	1606	1655
2259 x 2036	7568	1192	1241	1241	1290	-	-
2259 x 2136	7570	1192	1241	1241	1290	1618	1667
2259 x 2286	7572	-	1241	-	1290	-	-
2284 x 1931	7664	1099	1148	1170	1219	1606	1655
2284 x 1981	7666	1099	1148	1170	1219	1606	1655
2284 x 2031	7668	1161	1210	1236	1285	-	-
2284 x 2136	7670	1193	1242	<b>1241</b>	1290	1618	1667
2284 x 2186	7672	-	-	-	1359	-	-
2439 x 1931	8064	-	-	-	1356	-	1728
2439 x 1981	8066	-	-	-	1356	-	1728
2439 x 2031	8068	-	-	-	1432	-	-
2439 x 2136	8070	-	-	-	1385	-	1741
2439 x 2186	8072	-	-	-	1463	-	-
2590 x 1981	8666	-	-	-	1433	-	-
2590 x 2136	8670	-	-	-	1476	-	-
2744 x 1981	9066	-	-	-	1505	-	-
2744 x 2136	9070	-	-	-	1564	-	-

Stock doors also available in Jet Black (based on RAL 9005).

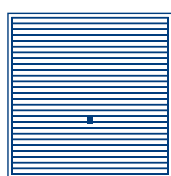
**Single door -  
purpose-made sizes**Nominal Door Size  
Width x Height  
(mm x mm)

Horizon

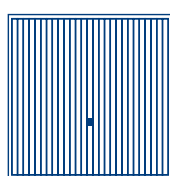

Carlton

		Horizon		Carlton	
		C	R	C	R
1985-2134	x 1830-1930	1297	1346	1329	1378
1985-2134	x 1931-1981	1347	1396	1382	1431
1985-2134	x 1982-2136	1423	1472	1441	1490
2135-2284	x 1830-1930	1347	1396	1368	1417
2135-2284	x 1931-1981	1423	1472	1423	1472
2135-2284	x 1982-2136	1482	1531	1517	1566
2285-2499	x 1830-1930	-	-	-	1503
2285-2499	x 1931-1981	-	-	-	1567
2285-2499	x 1982-2136	-	-	-	1627
2500-2590	x 1830-1930	-	-	-	1587
2500-2590	x 1931-1981	-	-	-	1637
2500-2590	x 1982-2136	-	-	-	1694
2591-2722	x 1830-1930	-	-	-	1635
2591-2722	x 1931-1981	-	-	-	1686
2591-2722	x 1982-2136	-	-	-	1774

Orders for purpose made sizes will only be accepted as overall frame size when ordering a framed version. Orders for purpose made framed doors will not be accepted as nominal door size.

**Options for single doors**

add

For powder-coated doors: Brown (RAL 8028)

37

For powder coated doors: Moss Green (RAL 6005), Ruby Red (RAL 3003), Signal Blue (RAL 5005), Jet Black (RAL 9005), Steel Blue (RAL 5011), Light Ivory (RAL 1015), Pigeon Blue (RAL 5014), Fir Green (RAL 6009), Anthracite Grey (RAL 7016), Stone Grey (RAL 7030), Light Grey (RAL 7035), Slate Grey (RAL 7015), Clay Brown (RAL 8003), Window Grey (RAL 7040), Chartwell Green (BS 4800), Burgundy Brown and Golden Brown (solid).

123

Coloured window frames on Salisbury to match door colour<sup>1</sup>

155

Retractable plus gear (available up to 80 (2439) wide but in standard heights only - 64 (1931), 66 (1981) and 70 (2134))

39

<sup>1</sup> Colour match windows not available in Burgundy Brown or Golden Brown.



Secured by Design is an association focusing on the design of more secure homes and commercial properties.

Secured by Design is owned by the ACPO (Association of Chief Police Officers) and awards the Secured by Design status to products that pass their extensive testing procedures.

# Design Range

## Surface and finish

The Series 100 Design Range skins are built from four horizontal skins, whilst the Series 200 range is constructed from three vertical skins. Stainless steel elements on Garador design range doors are manufactured from high grade 2 mm thick steel with a brushed finish. The series 100 and 200 design range doors are also available without stainless steel elements. On Design Range doors a choice of any standard colour comes free of charge, please see page 17 for a choice of the 19 standard RAL colours available.

Please note: panel doors are produced with appearance in mind. This may result in some small gaps which could allow water ingress especially in exposed locations.

## Handle and Packaging

A new perfectly matched handle offers a quality feel everytime you open the door. Design Range doors come wrapped as standard.

## Terminology



**Nominal Door Size:** This is the actual door panel size plus the fitting tolerances. The nominal door size should be used for internal dimensions of a timber frame.

**Size Code:** This has traditionally been used to order doors. This may not be the actual door size.

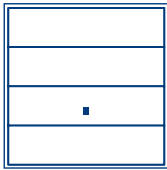
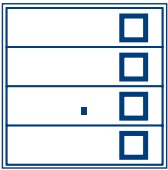
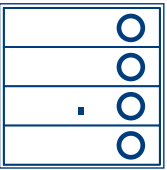
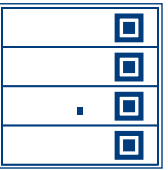
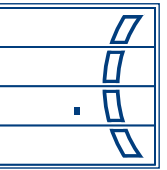
### Single door

Nominal Door Size Width x Height (mm x mm)	Size Code										
		C	R	C	R	C	R	C	R	C	R
2134 x 1981	7066	965	1014	1157	1206	1157	1206	1157	1206	1157	1206
2134 x 2136	7070	1029	1078	1221	1270	1221	1270	1221	1270	1221	1270
2259 x 1981	7566	1061	1110	1254	1303	1254	1303	1254	1303	1254	1303
2259 x 2136	7570	1124	1173	1319	1368	1319	1368	1319	1368	1319	1368
2284 x 1981	7666	1081	1130	1272	1321	1272	1321	1272	1321	1272	1321
2284 x 2136	7670	1144	1193	1336	1385	1336	1385	1336	1385	1336	1385
2439 x 1981	8066	1221	1270	1412	1461	1412	1461	1412	1461	1412	1461
2439 x 2136	8070	1285	1334	1477	1526	1477	1526	1477	1526	1477	1526

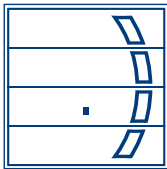
### Single door

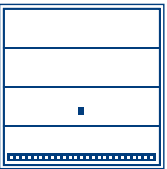
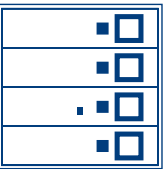
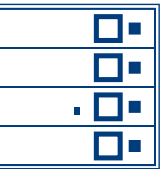
Nominal Door Size Width x Height (mm x mm)	Size Code										
		C	R	C	R	C	R	C	R	C	R
2134 x 1981	7066	1157	1206	1157	1206	1157	1206	1157	1206	1157	1206
2134 x 2136	7070	1221	1270	1221	1270	1221	1270	1221	1270	1221	1270
2259 x 1981	7566	1254	1303	1254	1303	1254	1303	1254	1303	1254	1303
2259 x 2136	7570	1319	1368	1319	1368	1319	1368	1319	1368	1319	1368
2284 x 1981	7666	1272	1321	1272	1321	1272	1321	1272	1321	1272	1321
2284 x 2136	7670	1336	1385	1336	1385	1336	1385	1336	1385	1336	1385
2439 x 1981	8066	1412	1461	1412	1461	1412	1461	1412	1461	1412	1461
2439 x 2136	8070	1477	1526	1477	1526	1477	1526	1477	1526	1477	1526



Single door

Nominal Door Size Width x Height (mm x mm)	Size Code	200		201		202		203		204	
		C	R	C	R	C	R	C	R	C	R
2134 x 1981	7066	965	1014	1157	1206	1157	1206	1157	1206	1157	1206
2134 x 2136	7070	1029	1078	1221	1270	1221	1270	1221	1270	1221	1270
2259 x 1981	7566	1061	1110	1254	1303	1254	1303	1254	1303	1254	1303
2259 x 2136	7570	1124	1173	1319	1368	1319	1368	1319	1368	1319	1368
2284 x 1981	7666	1081	1130	1272	1321	1272	1321	1272	1321	1272	1321
2284 x 2136	7670	1144	1193	1336	1385	1336	1385	1336	1385	1336	1385
2439 x 1981	8066	1221	1270	1412	1461	1412	1461	1412	1461	1412	1461
2439 x 2136	8070	1285	1334	1477	1526	1477	1526	1477	1526	1477	1526

Single door

Nominal Door Size Width x Height (mm x mm)	Size Code	205		207		210		211		212	
		C	R	C	R	C	R	C	R	C	R
2134 x 1981	7066	1157	1206	1157	1206	1157	1206	1157	1206	1157	1206
2134 x 2136	7070	1221	1270	1221	1270	1221	1270	1221	1270	1221	1270
2259 x 1981	7566	1254	1303	1254	1303	1254	1303	1254	1303	1254	1303
2259 x 2136	7570	1319	1368	1319	1368	1319	1368	1319	1368	1319	1368
2284 x 1981	7666	1272	1321	1272	1321	1272	1321	1272	1321	1272	1321
2284 x 2136	7670	1336	1385	1336	1385	1336	1385	1336	1385	1336	1385
2439 x 1981	8066	1412	1461	1412	1461	1412	1461	1412	1461	1412	1461
2439 x 2136	8070	1477	1526	1477	1526	1477	1526	1477	1526	1477	1526

Options for single doors

add

Factory pre-fitted steel frame

125

Additional Lock Kit, C-type/ R-type (fitted onto door)

58

Retractable plus gear

39

Please specify on order if you would like the design elements on the right or the left hand side of the door panel (viewed from outside).

Colour options on Design Range doors are free of charge. Available options are: White (RAL 9016), Terra Brown (RAL 8028), Moss Green (RAL 6005), Ruby Red (RAL 3003), Signal Blue (RAL 5005), Jet Black (RAL 9005), Steel Blue (RAL 5011), Light Ivory (RAL 1015), Pigeon Blue (RAL 5014), Fir Green (RAL 6009), Anthracite Grey (RAL 7016), Stone Grey (RAL 7030), Light Grey (RAL 7035), Slate Grey (RAL 7015), Clay Brown (RAL 8003), Window Grey (RAL 7040), Chartwell Green (BS 4800), Burgundy Brown and Golden Brown (solid).

Design Range doors come wrapped as standard

# GRP Premier Panel Doors

## Surface

High gloss or woodgrain finish depending on door style.

GRP Premier doors are constructed as an infill panel and are fixed into a rigid box section chassis.

The infill has a flow coat to the inside face for a smoother finish and reduced translucency.

Please note: panel doors are produced with appearance in mind. This may result in some small gaps which could allow water ingress especially in exposed locations.

## Standard colours

Arden and Stamford are available in Gloss White and Gloss Magnolia finish only. All other doors are available in the following range of woodgrain colours: White, Magnolia, Bleached Oak, Red Mahogany, Dark Mahogany, Light Oak, Dark Oak, Irish Oak, Honey Beech, Teak, Rosewood, Golden Brown, Ebony, Anthracite Grey and Gloss Magnolia.

Due to the production processes door colours may vary. Should you require matching doors please specify on your order.

## Premium colours

Our GRP premium colour range includes Blue and Green. There is an additional surcharge for these colours, see page 22 for details.

## Chassis colour

Traffic White (RAL 9016) for White Woodgrain and Gloss White doors, Black (RAL 9005) for Ebony coloured doors, Anthracite Grey (RAL 7016) for Anthracite Grey doors, Light Ivory (RAL 1015) for Magnolia Gloss and Magnolia doors, Fir Green (RAL 6009) for Green doors and Steel Blue (RAL 5011) for Blue doors.

Burgundy Brown will be used as the chassis colour for Red Mahogany, Dark Oak, Rosewood and Dark Mahogany.

All other doors will be supplied with a Terra Brown (RAL 8028) chassis.

## Handle

Black handle and base plate as standard, optional handles available. Doors can be supplied undrilled and without handle and locking mechanism for use with electric operator. This must be requested at the time of order.

Certain panel configurations may only be available without handle or locking, therefore only suitable for electric operation (consult Garador sales office for exact details).

## Terminology

**Nominal Door Size:** This is the actual door panel size plus the fitting tolerances. The nominal door size should be used for internal dimensions of a timber frame.

**Size Code:** This has traditionally been used to order doors. This may not be the actual door size.

## Packaging

Supplied with front surface protection as standard.

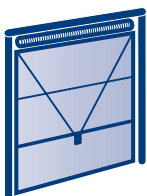

### Canopy gearing (shown as C)

Canopy gear is available for all single doors providing a reliable and affordable gearing solution, with no tracks running back into the garage.

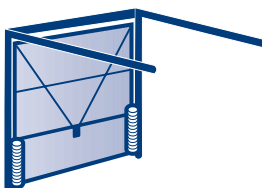

### Retractable gearing (shown as R)

Retractable gear is available for all single and double doors providing a reliable and affordable gearing solution, with tracks running back into the garage.

### Single door

Nominal Door Size  
Width x Height  
(mm x mm)

Size  
Code

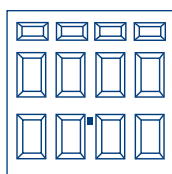

Arden

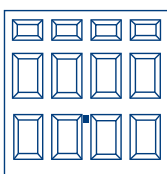

Kenmore

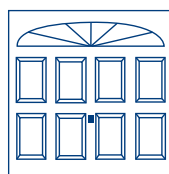

Stamford

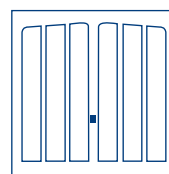

Penshurst

Nominal Door Size Width x Height (mm x mm)	Size Code	Arden		Kenmore		Stamford		Penshurst	
		C	R	C	R	C	R	C	R
2134 x 1981	7066	1934	1983	1973	2022	2030	2079	2094	2143
2134 x 2136	7070	1934	1983	1973	2022	2030	2079	2094	2143
2259 x 1981	7566	2023	2072	2075	2124	2112	2161	2256	2305
2259 x 2136	7570	2023	2072	2075	2124	2112	2161	2256	2305
2284 x 1981	7666	2039	2088	2094	2143	2136	2185	2278	2327
2284 x 2136	7670	2039	2088	2094	2143	2136	2185	2278	2327
2439 x 1981	8066	2227	2276	2251	2300	2312	2361	2424	2473
2439 x 2136	8070	2227	2276	2251	2300	2312	2361	2424	2473
2744 x 1981	9066	-	2482 <sup>1</sup>	-	2541 <sup>1</sup>	-	-	-	-
2744 x 2136	9070	-	2482 <sup>1</sup>	-	2541 <sup>1</sup>	-	-	-	-
3049 x 1981	1066	-	2725 <sup>1</sup>	-	2812 <sup>1</sup>	-	-	-	-
3049 x 2136	1070	-	2725 <sup>1</sup>	-	2812 <sup>1</sup>	-	-	-	-

<sup>1</sup> Doors only available with electric operation (Handle and Locking not available).

### Single door

Nominal Door Size  
Width x Height  
(mm x mm)

Size  
Code

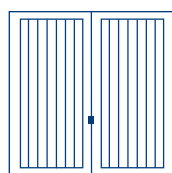

Swinton

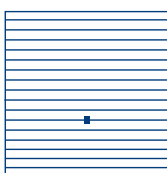

Glastonbury

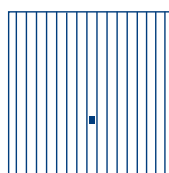

Somerset

Nominal Door Size Width x Height (mm x mm)	Size Code	Swinton		Glastonbury		Somerset	
		C	R	C	R	C	R
2134 x 1981	7066	2094	2143	2094	2143	2094	2143
2134 x 2136	7070	2094	2143	2094	2143	2094	2143
2259 x 1981	7566	2256	2305	2256	2305	2256	2305
2259 x 2136	7570	2256	2305	2256	2305	2256	2305
2284 x 1981	7666	2278	2327	2278	2327	2278	2327
2284 x 2136	7670	2278	2327	2278	2327	2278	2327
2439 x 1981	8066	2424	2473	-	-	2424	2473
2439 x 2136	8070	2424	2473	-	-	2424	2473
2744 x 1981	9066	-	-	-	-	-	2715
2744 x 2136	9070	-	-	-	-	-	2715
3049 x 1981	1066	-	-	-	-	-	2982
3049 x 2136	1070	-	-	-	-	-	2982

Please note that doors with windows may have cross bracing or locking rods passing behind the windows depending upon size and gear type.

For further options please see page 22.

### Single door

Nominal Door Size  
Width x Height  
(mm x mm)

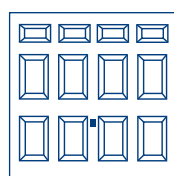

Arden

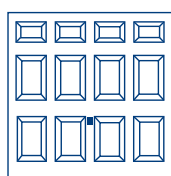

Kenmore

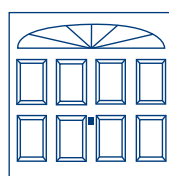

Stamford

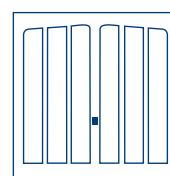

Penshurst

		Arden		Kenmore		Stamford		Penshurst	
		C	R	C	R	C	R	C	R
2032-2133	x 1931-1980	-	-	-	-	-	-	2312	2361
2032-2133	x 1981-2136	-	-	-	-	-	-	2312	2361
2032-2133	x 2137-2286	-	-	-	-	-	-	-	2671
2134-2439	x 1931-1980	-	-	-	-	-	-	2654	2703
2134-2439	x 1981-2136	2440	2489	2468	2517	2537	2586	2654	2703
2134-2439	x 2137-2286	-	2814	-	2847	-	-	-	3071
2440-2590	x 1931-1980	-	-	-	-	-	-	-	-
2440-2590	x 1981-2136	-	-	-	-	-	-	-	-
2440-2590	x 2137-2286	-	-	-	-	-	-	-	-
2591-2744	x 1931-1980	-	-	-	-	-	-	-	-
2591-2744	x 1981-2136	-	-	-	2842 <sup>1</sup>	-	-	-	-
2591-2744	x 2137-2286	-	-	-	-	-	-	-	-
2745-2896	x 1931-1980	-	-	-	-	-	-	-	-
2745-2896	x 1981-2136	-	3023 <sup>1</sup>	-	3106 <sup>1</sup>	-	-	-	-
2745-2896	x 2137-2286	-	-	-	-	-	-	-	-
2897-3049	x 1931-1980	-	-	-	-	-	-	-	-
2897-3049	x 1981-2136	-	3023 <sup>1</sup>	-	3106 <sup>1</sup>	-	-	-	-
2897-3049	x 2137-2286	-	-	-	-	-	-	-	-

<sup>1</sup> Doors only available with electric operation (Handle and Locking not available).

### Single door

Nominal Door Size  
Width x Height  
(mm x mm)

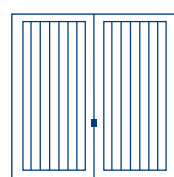

Swinton

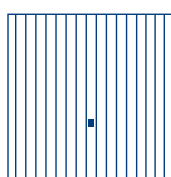

Somerset

		Swinton		Somerset	
		C	R	C	R
2259-2439	x 1981-2136	2654	2703	2654	2703
2259-2439	x 2150-2286	-	2873	2654	2703
2440-2590	x 1931-1980	-	-	2693	2742
2440-2590	x 1981-2136	-	-	2693	2742
2440-2590	x 2137-2286	-	-	2693	2742
2591-2744	x 1931-1980	-	-	2855	2904
2591-2744	x 1981-2136	-	-	2855	2904
2591-2744	x 2137-2286	-	-	2855	2904
2745-2896	x 1931-1980	-	-	3083	3132
2745-2896	x 1981-2136	-	-	3083	3132
2745-2896	x 2137-2286	-	-	3083	3132
2897-3049	x 1931-1980	-	-	3267	3316
2897-3049	x 1981-2136	-	-	3267	3316
2897-3049	x 2137-2286	-	-	3267	3316

Orders for purpose made sizes will only be accepted as nominal door size for unframed version and overall frame size when ordering a framed version. Orders for purpose made framed doors will not be accepted as nominal door size. Please note that doors with windows may have cross bracing or locking rods passing behind the windows depending upon size and gear type. For further options please see page 22.

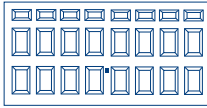
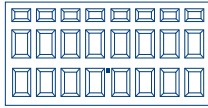
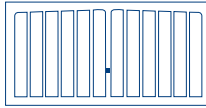
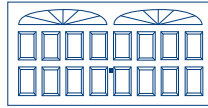
Double door					
Nominal Door Size Width x Height (mm x mm)	Size Code	Arden R	Kenmore R	Penshurst R	Stamford R
3354 x 1981	1166	2725	2834	-	-
3354 x 2136	1170	2725	2834	-	-
3354 x 2286	1176	2725	-	-	-
3659 x 1981	1266	2950 <sup>1</sup>	3080 <sup>1</sup>	-	-
3659 x 2136	1270	2950 <sup>1</sup>	3080 <sup>1</sup>	-	-
3659 x 2286	1276	2950	-	-	-
3964 x 1981	1366	3169 <sup>1</sup>	3326 <sup>1</sup>	-	-
3964 x 2136	1370	3169 <sup>1</sup>	3326 <sup>1</sup>	-	-
3964 x 2286	1376	3169	-	-	-
4269 x 1981	1466	3389	3581	3730	3744 <sup>1</sup>
4269 x 2136	1470	3389	3581	3730	3744 <sup>1</sup>
4269 x 2286	1476	3389	-	-	-

<sup>1</sup> Doors only available with electric operation (Handle and Locking not available).

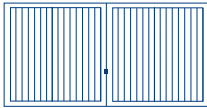
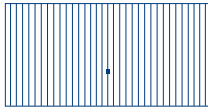
Double door			
Nominal Door Size Width x Height (mm x mm)	Size Code	Swinton R	Somerset R
3354 x 1981	1166	-	2834
3354 x 2136	1170	-	2834
3354 x 2286	1176	-	-
3659 x 1981	1266	-	3080
3659 x 2136	1270	-	3080
3659 x 2286	1276	-	-
3964 x 1981	1366	-	3326
3964 x 2136	1370	-	3326
3964 x 2286	1376	-	-
4269 x 1981	1466	-	3635
4269 x 2136	1470	3744	3635
4269 x 2286	1476	-	-

<sup>1</sup> Doors only available with electric operation (Handle and Locking not available).

Please note that doors with windows may have cross bracing or locking rods passing behind the windows depending upon size and gear type.

For further options please see page 22.

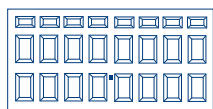
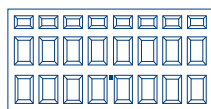
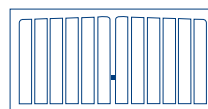
**Double door**Nominal Door Size  
Width x Height  
(mm x mm)**Arden****R****Kenmore****R****Penshurst****R**

3050-3355	x	1981-2136	2911	3030	-
3050-3355	x	2137-2286	3019	-	-
3356-3660	x	1981-2136	3129 <sup>1</sup>	3275 <sup>1</sup>	-
3356-3660	x	2137-2286	3236	-	-
3661-3965	x	1981-2136	3348 <sup>1</sup>	3521 <sup>1</sup>	-
3661-3965	x	2137-2286	3457	-	-
3966-4117	x	1981-2136	3567 <sup>1</sup>	3758 <sup>1</sup>	-
3966-4117	x	2137-2286	3567	-	-
4118-4269	x	1981-2136	3567	3758	3913
4118-4269	x	2137-2286	3775	-	-

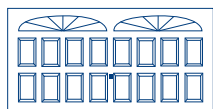
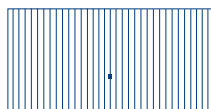
<sup>1</sup> Doors only available with electric operation (Handle and Locking not available).**Double door**Nominal Door Size  
Width x Height  
(mm x mm)**Stamford****R****Somerset****R**







3050-3355	x	1981-2136	-	3030
3050-3355	x	2137-2286	-	3030
3356-3660	x	1981-2136	-	3275
3356-3660	x	2137-2286	-	3275
3661-3965	x	1981-2136	-	3521
3661-3965	x	2137-2286	-	3521
3966-4117	x	1981-2136	-	3758
3966-4117	x	2137-2286	-	3758
4118-4269	x	1981-2136	3939 <sup>1</sup>	3913
4118-4269	x	2137-2286	-	3913

<sup>1</sup> Doors only available with electric operation (Handle and Locking not available).

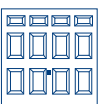
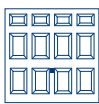





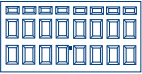

Orders for purpose made sizes will only be accepted as nominal door size for unframed version and overall frame size when ordering a framed version. Orders for purpose made framed doors will not be accepted as nominal door size.

**Options**

	Single doors add	Double doors add
Factory pre-framed standard single doors	125	-
Steel frame for standard double doors	-	189
Factory pre-framed purpose-made single doors	142	-
Steel frame for purpose-made double doors	-	210
Additional Lock Kit, C-type/ R-type (fitted onto door)	58	-
Retractable plus gear available on 1931, 1981 and 2136 mm high doors up to 2744 mm wide	39	-
Diecast metal handles with matching base plates: brass effect, brushed steel, chrome effect and white	44	44
Surcharge for Premium colours Green and Blue	288	575
Surcharge for steel frame in colour not matching garage door	125	-
Surcharge for colour steel frame on Matt or Gloss White Garage door	123	194

GRP Window options  for standard and purpose-made single doors				Additional Cost (Width mm)	
	Stamford	Arden	Kenmore	up to 2743	2744-3049
 Clear Perspex	X	X	X	155	231
 Stippled Perspex	X	X	X	156	231
 Stippled Perspex with diamond leading	-	X	X	257	379
 Stippled Perspex with square leading	-	X	X	257	379
 Black Non-Translucent	X	X	X	156	231
 Black Non-Translucent Perspex with border and diamond leading	-	X	X	257	379

Please state window code on order.

GRP Window options  for standard and purpose-made double doors				Additional Cost (Width mm)	
	Stamford	Arden	Kenmore	3354 - 3963	3964 - 4269
 Clear Perspex	X	X	X	272	309
 Stippled Perspex	X	X	X	272	309
 Stippled Perspex with diamond leading	-	X	X	443	532
 Stippled Perspex with square leading	-	X	X	443	532
 Black Non-Translucent	X	X	X	272	309
 Black Non-Translucent Perspex with border and diamond leading	-	X	X	443	532

Please state window code on order.

Please note that doors with windows may have cross bracing or locking rods passing behind the windows depending upon size and gear type.

# Timber Panel Doors

## Surface

Timber doors are supplied untreated and require immediate on-site finishing unless fully finished option specified. Timber is a natural material and therefore Garador cannot guarantee to be able to produce matching timber garage doors. Chassis colours will be Brown (RAL 8028) on all timber doors

Please note: panel doors are produced with appearance in mind. This may result in some small gaps which could allow water ingress especially in exposed locations. All Garador timber garage doors are plywood backed, the timber boards are not visible from the inside of the garage door.

## Handle

Black handle and base plate supplied as standard, optional handles available. Doors can alternatively be supplied undrilled and without handle and locking mechanism for use with electric operator.

## Packaging

Supplied with front surface protection as standard.

## Terminology

**Nominal Door Size:** This is the actual door panel size plus the fitting tolerances. The nominal door size should be used for internal dimensions of a timber frame.

**Size Code:** This has traditionally been used to order doors. This may not be the actual door size.

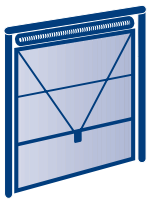

### Canopy gearing (shown as C)

Canopy gear is available for all single doors providing a reliable and affordable gearing solution, with no tracks running back into the garage.

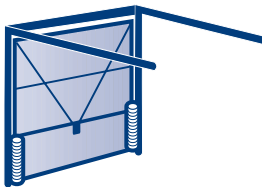

### Retractable gearing (shown as R)



Retractable gear is available for all single and double doors providing a reliable and affordable gearing solution, with tracks running back into the garage.

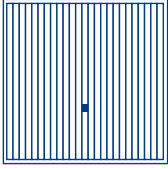
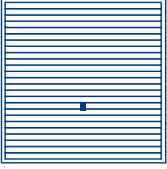
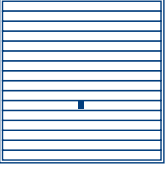
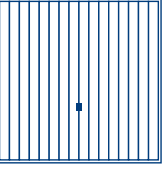
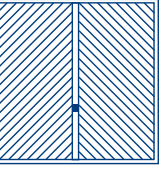

**Single door**

Nominal Door Size Width x Height (mm x mm)	Size Code										
		Vertical Cedar		Horizontal Cedar		Countryman		Hampton		Chevron Cedar	
		C	R	C	R	C	R	C	R	C	R
2134 x 1981	7066	1607	1656	1690	1739	2006	2055	2006	2055	2388	2437
2134 x 2136	7070	1622	1671	1705	1754	2023	2072	2023	2072	2427	2476
2134 x 2286	7076	-	1835	-	1928	-	2275	-	2275	-	2562
2259 x 1981	7566	1690	1739	1778	1827	2110	2159	2110	2159	2549	2598
2259 x 2136	7570	1706	1755	1795	1844	2128	2177	2128	2177	2561	2610
2284 x 1981	7666	1690	1739	1948	1997	2110	2159	2110	2159	2549	2598
2284 x 2136	7670	1706	1755	1795	1844	2128	2177	2128	2177	2561	2610
2284 x 2286	7676	-	1904	-	2002	-	2282	-	2282	-	2687
2439 x 1981	8066	1789	1838	1883	1932	2231	2280	2231	2280	2633	2682
2439 x 2136	8070	1803	1852	1897	1946	2249	2298	2249	2298	2648	2697
2439 x 2286	8076	-	2019	-	2119	-	2417	-	2417	-	2759
2744 x 1981	9066	-	2108	-	2215	-	2517	-	2517	-	2936
2744 x 2136	9070	-	2123	-	2228	-	2544	-	2544	-	2978
2744 x 2286	9076	-	2316	-	2435	-	2725	-	2725	-	3077
3049 x 1981	1066	-	2441	-	2561	-	2843	-	2843	-	3297
3049 x 2136	1070	-	2464	-	2589	-	2867	-	2867	-	3322

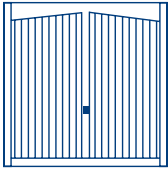
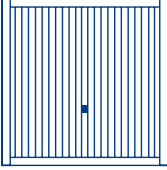
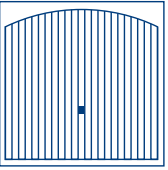
**Single door**

Nominal Door Size Width x Height (mm x mm)	Size Code										
		Barrington		Kingsbury		Adlington		Ashton <sup>1</sup>		Rochdale <sup>1</sup>	
		C	R	C	R	C	R	C	R	C	R
2134 x 1981	7066	2040	2089	2023	2072	1838	1887	2388	2437	2415	2464
2134 x 2136	7070	2053	2102	2039	2088	1838	1887	2427	2476	2430	2479
2134 x 2286	7076	-	2274	-	2254	-	2032	-	2562	-	2593
2259 x 1981	7566	2121	2170	2103	2152	1918	1967	2549	2598	2502	2551
2259 x 2136	7570	2134	2183	2119	2168	1918	1967	2561	2610	2515	2564
2284 x 1981	7666	2121	2170	2103	2152	1918	1967	2549	2598	2502	2551
2284 x 2136	7670	2134	2183	2119	2168	1918	1967	2561	2610	2515	2564
2284 x 2286	7676	-	2350	-	2333	-	2123	-	2687	-	2642
2439 x 1981	8066	2195	2244	2176	2225	2110	2159	2633	2682	2582	2631
2439 x 2136	8070	2209	2258	2192	2241	2110	2159	2648	2697	2603	2652
2439 x 2286	8076	-	2417	-	2398	-	2163	-	2759	-	2708
2744 x 1981	9066	-	2504	-	2420	-	2250	-	2936	-	2954
2744 x 2136	9070	-	2526	-	2441	-	2250	-	2978	-	3002
2744 x 2286	9076	-	2724	-	2642	-	2427	-	3077	-	3096
3049 x 1981	1066	-	2833	-	2749	-	2431	-	3297	-	3321
3049 x 2136	1070	-	2856	-	2771	-	2431	-	3322	-	3344

<sup>1</sup> Ashton and Rochdale doors may have cross bracing and / or locking rods behind the windows depending upon the size and gear type.

For further options please see page 33.

Single door

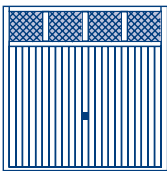
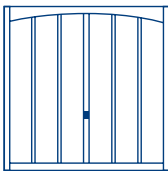
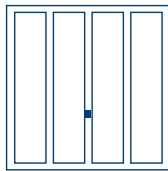
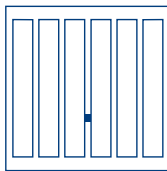
Nominal Door Size Width x Height (mm x mm)	Size Code								
		Sandhurst <sup>1</sup>		Shaftesbury		Grantham		Seymour	
		C	R	C	R	C	R	C	R
2134 x 1981	7066	2340	2389	1813	1862	1220	1269	1732	1781
2134 x 2136	7070	2355	2404	1824	1873	1220	1269	1747	1796
2134 x 2286	7076	-	2515	-	1961	-	1345	-	1880
2259 x 1981	7566	2426	2475	1847	1896	1300	1349	1768	1817
2259 x 2136	7570	2441	2490	1861	1910	1300	1349	1783	1832
2284 x 1981	7666	2426	2475	1847	1896	1300	1349	1768	1817
2284 x 2136	7670	2441	2490	1861	1910	1300	1349	1783	1832
2284 x 2286	7676	-	2566	-	1987	-	1437	-	1908
2439 x 1981	8066	2507	2556	1878	1927	1349	1398	1798	1847
2439 x 2136	8070	2527	2576	1894	1943	1349	1398	1813	1862
2439 x 2286	8076	-	2632	-	2005	-	1494	-	1925
2744 x 1981	9066	-	2841	-	2274	-	1532	-	2177
2744 x 2136	9070	-	2888	-	2292	-	1532	-	2192
2744 x 2286	9076	-	2984	-	2399	-	1638	-	2284
3049 x 1981	1066	-	3206	-	2557	-	1665	-	2453
3049 x 2136	1070	-	3229	-	2581	-	1665	-	2455

<sup>1</sup> Sandhurst doors may have cross bracing and/or locking rods behind the windows depending upon the size and gear type.

Single door

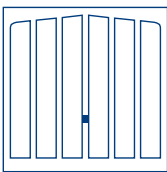
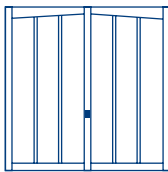
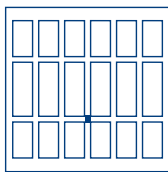
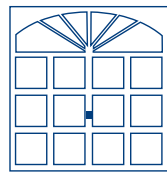
Nominal Door Size Width x Height (mm x mm)	Size Code								
		Tudor		Bosworth		Wolsey		Hinton <sup>2</sup>	
		C	R	C	R	C	R	C	R
2134 x 1981	7066	1813	1862	1836	1885	1811	1860	2512	2561
2134 x 2136	7070	1824	1873	1848	1897	1822	1871	2528	2577
2134 x 2286	7076	-	1961	-	1984	-	1959	-	2665
2259 x 1981	7566	1847	1896	1873	1922	1845	1894	2669	2718
2259 x 2136	7570	1861	1910	1886	1935	1858	1907	2684	2733
2284 x 1981	7666	1847	1896	1873	1922	1845	1894	2669	2718
2284 x 2136	7670	1861	1910	1886	1935	1858	1907	2684	2733
2284 x 2286	7676	-	1987	-	2013	-	1985	-	2808
2439 x 1981	8066	1878	1927	1902	1951	1876	1925	2748	2797
2439 x 2136	8070	1894	1943	1915	1964	1890	1939	2766	2815
2439 x 2286	8076	-	2005	-	2029	-	2003	-	2875
2744 x 1981	9066	-	2274	-	2298	-	2217	-	3104
2744 x 2136	9070	-	2292	-	2314	-	2234	-	3120
2744 x 2286	9076	-	2399	-	2422	-	2326	-	3225
3049 x 1981	1066	-	2557	-	2581	-	2477	-	3507
3049 x 2136	1070	-	2581	-	2603	-	2480	-	3528

<sup>2</sup> Hinton doors may have cross bracing and/or locking rods behind the windows depending upon the size and gear type.

For further options please see page 33.

Single door

Nominal Door Size  
Width x Height  
(mm x mm)

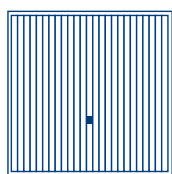

Vertical Cedar

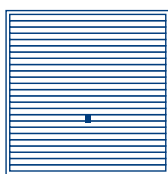

Horizontal Cedar

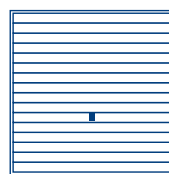

Countryman

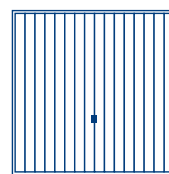

Hampton

		Vertical Cedar		Horizontal Cedar		Countryman		Hampton	
		C	R	C	R	C	R	C	R
1930-1984	x 1931-1981	1748	1797	1837	1886	2447	2496	2447	2496
1930-1984	x 1982-2136	1759	1808	1851	1900	2517	2566	2517	2566
1930-1984	x 2137-2286	-	1971	-	2071	-	2726	-	2726
1930-1984	x 2287-2439	-	2019	-	2119	-	2925	-	2925
1985-2284	x 1931-1981	1827	1876	1923	1972	2579	2628	2579	2628
1985-2284	x 1982-2136	1843	1892	1938	1987	2659	2708	2659	2708
1985-2284	x 2137-2286	-	2040	-	2141	-	2864	-	2864
1985-2284	x 2287-2439	-	2088	-	2191	-	3100	-	3100
2285-2439	x 1931-1981	1925 <sup>1</sup>	1974	2026 <sup>1</sup>	2075	2616 <sup>1</sup>	2665	2616 <sup>1</sup>	2665
2285-2439	x 1982-2136	1938 <sup>1</sup>	1987	2040 <sup>1</sup>	2089	2695 <sup>1</sup>	2744	2695 <sup>1</sup>	2744
2285-2439	x 2137-2286	-	2152	-	-	-	-	-	-
2285-2439	x 2287-2439	-	2234	-	-	-	-	-	-
2440-2744	x 1931-1981	-	2239	-	-	-	-	-	-
2440-2744	x 1982-2136	-	2254	-	-	-	-	-	-
2440-2744	x 2137-2286	-	2445	-	-	-	-	-	-
2440-2744	x 2287-2439	-	2512	-	-	-	-	-	-
2745-3049	x 1931-1981	-	2564	-	-	-	-	-	-
2745-3049	x 1982-2136	-	2590	-	-	-	-	-	-

<sup>1</sup> These doors are not available over 2438 mm wide.

Single door

Nominal Door Size  
Width x Height  
(mm x mm)

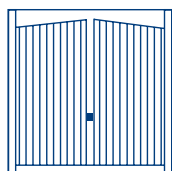

Barrington

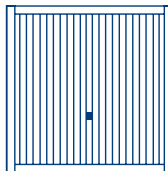

Kingsbury

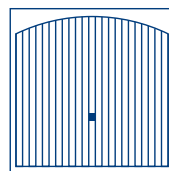

Adlington



Ashton<sup>2</sup>

		Barrington		Kingsbury		Adlington		Ashton <sup>2</sup>	
		C	R	C	R	C	R	C	R
1930-1984	x 1931-1981	2212	2261	2196	2245	1886	1935	2568	2617
1930-1984	x 1982-2136	2224	2273	2211	2260	1900	1949	2582	2631
1930-1984	x 2137-2286	-	2447	-	2426	-	2110	-	2799
1930-1984	x 2287-2439	-	2493	-	2480	-	2157	-	2852
1985-2284	x 1931-1981	2291	2340	2277	2326	1969	2018	2650	2699
1985-2284	x 1982-2136	2307	2356	2289	2338	1983	2032	2662	2711
1985-2284	x 2137-2286	-	2525	-	2504	-	2180	-	2876
1985-2284	x 2287-2439	-	2570	-	2557	-	2225	-	2930
2285-2439	x 1931-1981	2366 <sup>1</sup>	2415	2348 <sup>1</sup>	2397	2065 <sup>1</sup>	2114	2721	2770
2285-2439	x 1982-2136	2378 <sup>1</sup>	2427	2364 <sup>1</sup>	2413	2077 <sup>1</sup>	2126	2737	2786
2285-2439	x 2137-2286	-	2591	-	2569	-	2292	-	2942
2285-2439	x 2287-2439	-	2655	-	2642	-	2373	-	3015
2440-2744	x 1931-1981	-	2678	-	2594	-	2379	-	2967
2440-2744	x 1982-2136	-	2696	-	2613	-	2391	-	2984
2440-2744	x 2137-2286	-	2900	-	2816	-	2586	-	3188
2440-2744	x 2287-2439	-	2964	-	2881	-	2651	-	3253
2745-3049	x 1931-1981	-	3005	-	2921	-	2704	-	3293
2745-3049	x 1982-2136	-	3030	-	2944	-	2726	-	3316

<sup>1</sup> These doors are not available over 2438 mm wide.

<sup>2</sup> Ashton doors may have cross bracing and / or locking rods behind the windows depending upon the size and gear type.

Orders for purpose made sizes will only be accepted as nominal door size for unframed version and overall frame size when ordering a framed version. Orders for purpose made framed doors will not be accepted as nominal door size. For further options please see page 33.

### Single door

Nominal Door Size  
Width x Height  
(mm x mm)



Shaftesbury

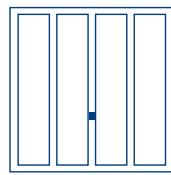

Grantham

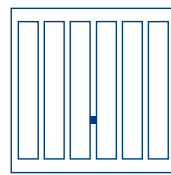

Seymour

		Shaftesbury		Grantham		Seymour	
		C	R	C	R	C	R
1930-1984	x 1931-1981	1903	1952	1598	1647	1903	1952
1930-1984	x 1982-2136	1918	1967	1611	1660	1918	1967
1930-1984	x 2137-2286	-	2053	-	1749	-	2053
1930-1984	x 2287-2439	-	2117	-	1812	-	2117
1985-2284	x 1931-1981	1940	1989	1635	1684	1940	1989
1985-2284	x 1982-2136	1956	2005	1650	1699	1956	2005
1985-2284	x 2137-2286	-	2081	-	1777	-	2081
1985-2284	x 2287-2439	-	2142	-	1839	-	2142
2285-2439	x 1931-1981	1971 <sup>1</sup>	2020	1667 <sup>1</sup>	1716	1971 <sup>1</sup>	2020
2285-2439	x 1982-2136	1984 <sup>1</sup>	2033	1679 <sup>1</sup>	1728	1984 <sup>1</sup>	2033
2285-2439	x 2137-2286	-	2098	-	1792	-	2098
2285-2439	x 2287-2439	-	2188	-	1881	-	2188
2440-2744	x 1931-1981	-	2348	-	2042	-	2348
2440-2744	x 1982-2136	-	2366	-	2061	-	2366
2440-2744	x 2137-2286	-	2456	-	2152	-	2456
2440-2744	x 2287-2439	-	2525	-	2218	-	2525
2745-3049	x 1931-1981	-	2627	-	2322	-	2627
2745-3049	x 1982-2136	-	2628	-	2323	-	2628

<sup>1</sup> These doors are not available over 2438 mm wide.

### Single door

Nominal Door Size  
Width x Height  
(mm x mm)

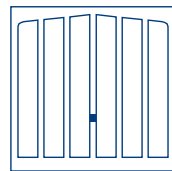

Tudor

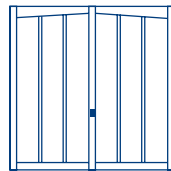

Bosworth

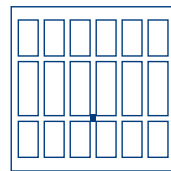

Wolsey

		Tudor		Bosworth		Wolsey	
		C	R	C	R	C	R
1930-1984	x 1931-1981	1984	2033	2008	2057	1982	2031
1930-1984	x 1982-2136	1997	2046	2022	2071	1994	2043
1930-1984	x 2137-2286	-	2132	-	2156	-	2130
1930-1984	x 2287-2439	-	2196	-	2221	-	2200
1985-2284	x 1931-1981	2021	2070	2045	2094	2018	2067
1985-2284	x 1982-2136	2036	2085	2058	2107	2032	2081
1985-2284	x 2137-2286	-	2161	-	2186	-	2157
1985-2284	x 2287-2439	-	2224	-	2250	-	2229
2285-2439	x 1931-1981	2051 <sup>1</sup>	2100	2074 <sup>1</sup>	2123	2048 <sup>1</sup>	2097
2285-2439	x 1982-2136	2065 <sup>1</sup>	2114	2089 <sup>1</sup>	2138	2063 <sup>1</sup>	2112
2285-2439	x 2137-2286	-	2178	-	2199	-	2176
2285-2439	x 2287-2439	-	2300	-	2323	-	2273
2440-2744	x 1931-1981	-	2447	-	2469	-	2388
2440-2744	x 1982-2136	-	2464	-	2488	-	2407
2440-2744	x 2137-2286	-	2570	-	2595	-	2498
2440-2744	x 2287-2439	-	2637	-	2661	-	2564
2745-3049	x 1931-1981	-	2730	-	2755	-	2651
2745-3049	x 1982-2136	-	2755	-	2776	-	2653

<sup>1</sup> These doors are not available over 2438 mm wide.

Orders for purpose made sizes will only be accepted as nominal door size for unframed version and overall frame size when ordering a framed version. Orders for purpose made framed doors will not be accepted as nominal door size.

For further options please see page 33.

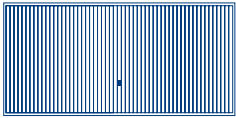
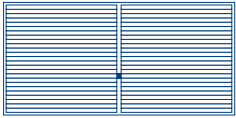
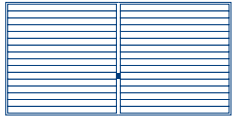
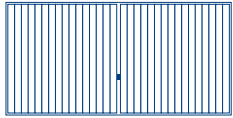
Double door					
Nominal Door Size Width x Height (mm x mm)	Size Code	Vertical Cedar R	Horizontal Cedar R	Countryman R	Hampton R
3049 x 2286	1076	2770	2807	3587	3587
3354 x 1981	1166	2770	2808	3551	3551
3354 x 2136	1170	2849	2887	3626	3626
3354 x 2286	1176	3080	3120	3933	3933
3659 x 1981	1266	3122	3165	3952	3952
3659 x 2136	1270	3202	3242	4029	4029
3659 x 2286	1276	3485	3530	4399	4399
3964 x 1981	1366	3691	3744	4356	4356
3964 x 2136	1370	3808	3860	4473	4473
3964 x 2286	1376	4133	4187	4863	4863
4269 x 1981	1466	3611	3666	4485	4485
4269 x 2136	1470	3691	3744	4563	4563
4574 x 1981	1566	4078	4134	-	-
4574 x 2136	1570	4195	4249	-	-
4879 x 1981	1666	4449	4508	-	-
4879 x 2136	1670	4486	4546	-	-

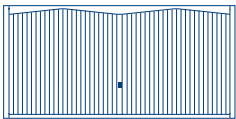
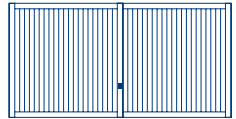
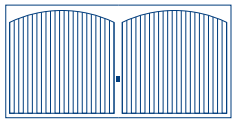
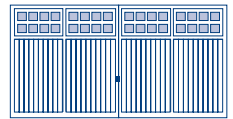
Double door					
Nominal Door Size Width x Height (mm x mm)	Size Code	Barrington R	Kingsbury R	Adlington R	Ashton <sup>1</sup> R
3049 x 2286	1076	3296	3143	3077	3661
3354 x 1981	1166	3270	3134	3018	3553
3354 x 2136	1170	3349	3212	3094	3630
3354 x 2286	1176	3630	3482	3352	3936
3659 x 1981	1266	3642	3503	3342	4082
3659 x 2136	1270	3720	3583	3419	4160
3659 x 2286	1276	4060	3927	3728	4543
3964 x 1981	1366	4238	4148	4047	4787
3964 x 2136	1370	4356	4263	4165	4905
3964 x 2286	1376	4734	4636	4526	5338
4269 x 1981	1466	4160	4070	3969	4710
4269 x 2136	1470	4238	4148	4047	4787
4574 x 1981	1566	4624	4565	-	5191
4574 x 2136	1570	4741	4681	-	5306
4879 x 1981	1666	4993	4935	-	5620
4879 x 2136	1670	5034	4975	-	5658

<sup>1</sup> Ashton doors may have cross bracing and/or locking rods behind the windows depending upon the size and gear type.

For further options please see page 33.

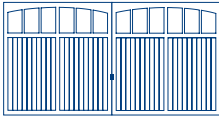
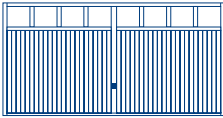
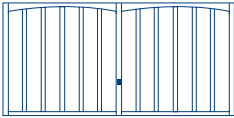

**Double door**

Nominal Door Size Width x Height (mm x mm)	Size Code			
		Rochdale <sup>1,2</sup>	Sandhurst <sup>1</sup>	Shaftesbury
		R	R	R
3049 x 2286	1076	3874	3405	2676
3354 x 1981	1166	3746	3383	2642
3354 x 2136	1170	3825	3460	2719
3354 x 2286	1176	4152	3753	2939
3659 x 1981	1266	4275	3816	2932
3659 x 2136	1270	4356	3895	3009
3659 x 2286	1276	4757	4249	3275
3964 x 1981	1366	4983	4454	3415
3964 x 2136	1370	5101	4569	3531
3964 x 2286	1376	5549	4972	3825
4269 x 1981	1466	4905	4375	3338
4269 x 2136	1470	4983	4454	3415
4574 x 1981	1566	5552	4975	3825
4574 x 2136	1570	5669	5094	3941
4879 x 1981	1666	5931	5520	4253
4879 x 2136	1670	5969	5560	4294

<sup>1</sup> Rochdale and Sandhurst doors may have cross bracing and/or locking rods behind the windows depending upon the size and gear type.

<sup>2</sup> Rochdale doors up to 3659 mm wide will be manufactured with one arch not the two as shown above.

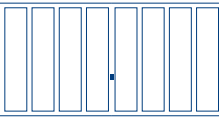
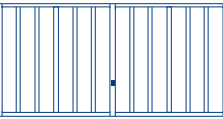
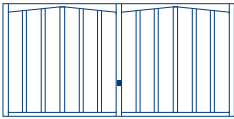
**Double door**

Nominal Door Size Width x Height (mm x mm)	Size Code				
		Grantham	Seymour	Tudor	Wolsey
		R	R	R	R
3049 x 2286	1076	2342	2649	2676	3005
3354 x 1981	1166	2293	2565	2642	2974
3354 x 2136	1170	2370	2642	2719	3053
3354 x 2286	1176	2554	2852	2939	3270
3659 x 1981	1266	2593	2894	2932	3264
3659 x 2136	1270	2671	2970	3009	3342
3659 x 2286	1276	2902	3234	3275	3606
3964 x 1981	1366	2902	3375	3415	3747
3964 x 2136	1370	3018	3493	3531	3864
3964 x 2286	1376	3259	3785	3825	4156
4269 x 1981	1466	2824	3296	3338	3669
4269 x 2136	1470	2902	3375	3415	3747
4574 x 1981	1566	-	-	3825	4156
4574 x 2136	1570	-	-	3941	4272
4879 x 1981	1666	-	-	4253	4586
4879 x 2136	1670	-	-	4294	4624

For further options please see page 33.

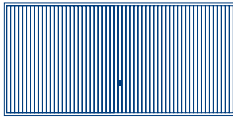
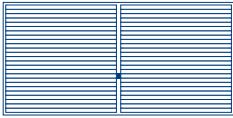
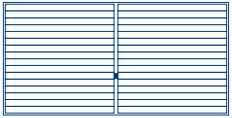
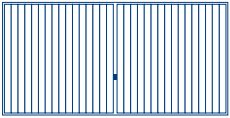

**Double door**

Nominal Door Size  
Width x Height  
(mm x mm)

				
	Vertical Cedar	Horizontal Cedar	Countryman	Hampton
	R	R	R	R
2745-3049 x 2137-2286	-	-	-	-
3050-3659 x 1931-1981	3434	3482	4216	4216
3050-3659 x 1982-2136	3520	3567	4300	4300
3050-3659 x 2137-2286	3833	3884	4697	4697
3660-4269 x 1931-1981	4187	4246	4994	4994
3660-4269 x 1982-2136	4319	4375	5123	5123
3660-4269 x 2137-2286	4533	4593	5379	5379
4270-5000 x 1931-1981	4893	4958	-	-
4270-5000 x 1982-2136	4935	5000	-	-

**Double door**

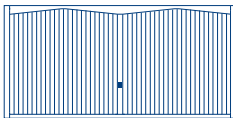
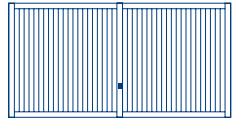
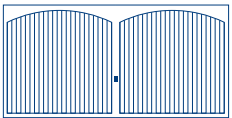
Nominal Door Size  
Width x Height  
(mm x mm)

				
	Barrington	Kingsbury	Adlington	Ashton <sup>1</sup>
	R	R	R	R
2745-3049 x 2137-2286	-	-	-	4024
3050-3659 x 1931-1981	4005	3856	3673	4488
3050-3659 x 1982-2136	4091	3941	3759	4574
3050-3659 x 2137-2286	4465	4319	4098	4994
3660-4269 x 1931-1981	4790	4694	4582	5395
3660-4269 x 1982-2136	4918	4821	4709	5522
3660-4269 x 2137-2286	5164	5059	4945	5799
4270-5000 x 1931-1981	5493	5430	-	6179
4270-5000 x 1982-2136	5538	5472	-	6222

<sup>1</sup> Ashton doors may have cross bracing and/or locking rods behind the windows depending upon the size and gear type.

Orders for purpose made sizes will only be accepted as nominal door size for unframed version and overall frame size when ordering a framed version. Orders for purpose made framed doors will not be accepted as nominal door size.

For further options please see page 33.

**Double door**

Nominal Door Size  
Width x Height  
(mm x mm)

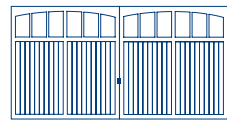

Rochdale<sup>1,2</sup>

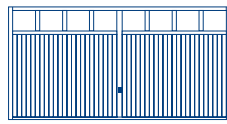

Sandhurst<sup>1</sup>

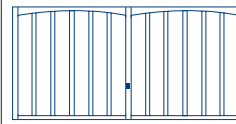

Shaftesbury

	R	R	R
2745-3049 x 2137-2286	4261	3744	2940
2745-3049 x 2287-2439	4476	3931	3089
3050-3659 x 1931-1981	4704	4198	3225
3050-3659 x 1982-2136	4790	4284	3309
3050-3659 x 2137-2286	5232	4674	3601
3050-3659 x 2287-2439	5491	4908	3782
3660-4269 x 1931-1981	5610	5026	3885
3660-4269 x 1982-2136	5738	5154	4015
3660-4269 x 2137-2286	6025	5411	4215
3660-4269 x 2287-2439	6311	5669	4414
4270-5000 x 1931-1981	6524	6074	4678
4270-5000 x 1982-2136	6566	6115	4722

<sup>1</sup> Rochdale and Sandhurst doors may have cross bracing and/or locking rods behind the windows depending upon the size and gear type.

<sup>2</sup> Rochdale doors up to 3659 mm wide will be manufactured with one arch not the two as shown above.

**Double door**

Nominal Door Size  
Width x Height  
(mm x mm)

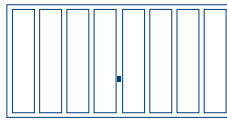

Grantham

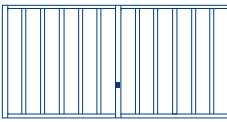

Seymour

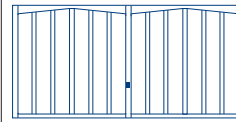

Tudor

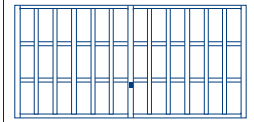



Wolsey

	R	R	R	R
2745-3049 x 2137-2286	2575	2914	2940	3271
2745-3049 x 2287-2439	2705	3061	3089	3420
3050-3659 x 1931-1981	2850	3181	3225	3557
3050-3659 x 1982-2136	2937	3267	3309	3642
3050-3659 x 2137-2286	3190	3559	3601	3933
3050-3659 x 2287-2439	3349	3737	3782	4111
3660-4269 x 1931-1981	3318	3841	3885	4217
3660-4269 x 1982-2136	3446	3971	4015	4343
3660-4269 x 2137-2286	3620	4169	4215	4546
3660-4269 x 2287-2439	3793	4368	4414	4745
4270-5000 x 1931-1981	-	-	4678	5009
4270-5000 x 1982-2136	-	-	4722	5052

Orders for purpose made sizes will only be accepted as nominal door size for unframed version and overall frame size when ordering a framed version. Orders for purpose made framed doors will not be accepted as nominal door size.

For further options please see page 33.



Timber door window options						
	Standard		Georgian <sup>1</sup>		Diagonal <sup>1</sup>	
	Single doors	Double doors	Single doors	Double doors	Single doors	Double doors
Prices in £ stated per door						
Plain	no on-cost	no on-cost	110	152	110	152
Crystal	no on-cost	no on-cost	110	152	110	152

<sup>1</sup> Only available on Sandhurst.

Windows are manufactured from 4 mm acrylic panes. Please state on order if clear or stippled panes required.

Options	Single doors	Double doors
	<b>add</b>	<b>add</b>
Factory pre-framed standard single doors	125	-
Steel frame for standard double doors	-	189
Factory pre-framed purpose-made single doors	142	-
Steel frame for purpose-made double doors	-	210
Additional Lock Kit, C-type/ R-type (fitted onto door)	58	-
Retractable plus gear available on 1931, 1981 and 2136 mm high doors up to 2744 mm wide	39	-
Factory fully finished stain in Light Oak, Antique Oak, Mahogany, Walnut, Chestnut and Ebony	144	214
Factory white primer ready for on-site painting	196	300
Factory fully finished painting (any RAL colour timber only)	325	564
Diecast metal handles with matching base plates: brass effect, chrome effect, brushed steel and white	44	44
Bottom weatherseal, 2405 mm length (suitable for gaps up to 15 mm between the door and the floor level)	41	41
Bottom weatherseal, 3000 mm length (suitable for gaps up to 15 mm between the door and the floor level)	46	46
Surcharge for colour steel Chassis and/or frame finished in RAL colour (no additional charge for Brown RAL8028 or White RAL9016 chassis and frame)	123	194

# Steel and Timber Garage Side Doors

## Surface

Steel doors constructed around a strong steel box section chassis in Traffic White (RAL 9016) as standard. Timber doors constructed using solid red cedar, built around a strong steel box section chassis. A range of stain options are available. All Garador timber garage side doors are plywood backed, the timber boards are not visible from the inside of the garage door.

## Handle

Supplied with lever/lever handle on left side (viewed outside)

## Terminology





Nominal Door Size: This is the actual door panel size plus the fitting tolerances. The nominal door size should be used for internal dimensions of a timber frame.

Size Code: This has traditionally been used to order doors. This may not be the actual door size.

## Stock Availability

4 to 6 week week lead-time on standard and purpose made sizes.

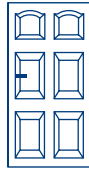
### Steel door - standard sizes

Nominal Door Size Width x Height (mm x mm)	Overall frame size (between fix) <sup>1</sup> Width x Height (mm x mm)	Size Code	 Georgian	 Beaumont	 Cathedral	 Beaumont with Windows <sup>2</sup>	 Carlton
762 x 1931	882 x 1989	2664	660 <sup>3</sup>	660 <sup>3</sup>	660 <sup>3</sup>	739 <sup>3</sup>	523
762 x 1981	882 x 2039	2666	674 <sup>3</sup>	674 <sup>3</sup>	674 <sup>3</sup>	752 <sup>3</sup>	538
762 x 2136	882 x 2194	2670	694 <sup>3</sup>	694 <sup>3</sup>	694 <sup>3</sup>	773 <sup>3</sup>	557
914 x 1931	1034 x 1989	3064	686 <sup>3</sup>	686 <sup>3</sup>	686 <sup>3</sup>	766 <sup>3</sup>	549
914 x 1981	1034 x 2039	3066	701 <sup>3</sup>	701 <sup>3</sup>	701 <sup>3</sup>	779 <sup>3</sup>	564
914 x 2136	1034 x 2194	3070	723 <sup>3</sup>	723 <sup>3</sup>	723 <sup>3</sup>	802 <sup>3</sup>	585
1067 x 1931	1187 x 1989	3664	714	714	714	795	577
1067 x 1981	1187 x 2039	3666	730	730	730	807	594
1067 x 2134	1187 x 2194	3670	748	748	748	828	612
1209 x 1931	1320 x 1989	4064	741	741	741	819	604
1209 x 1981	1320 x 2039	4066	755	755	755	835	620
1209 x 2136	1320 x 2194	4070	763	763	763	842	638

<sup>1</sup> No fitting clearance allowed.

<sup>2</sup> Windows for Beaumont: Standard () , Diamond () , Cross () . Please state on order if plain or crystal panes.



<sup>3</sup> Doors under 1000 mm width only have one vertical column of pressings. These doors vary from images shown.



### New product development

Due to on-going product development, garage side door prices maybe subject to future change.

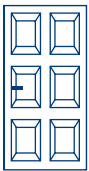
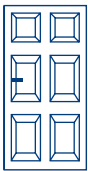
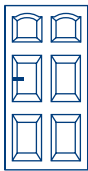
### Steel door - purpose-made sizes

Nominal Door Size Width x Height (mm x mm)	Overall frame size (between fix) <sup>1</sup> Width x Height (mm x mm)					
		Georgian	Beaumont	Cathedral	Beaumont with Windows <sup>2</sup>	Carlton
700-1066 x 1931-2136	820-1186 x 1989-2194	851 <sup>4</sup>	851 <sup>4</sup>	851 <sup>4</sup>	932 <sup>4</sup>	730
2067-1209 x 1931-2136	1187-1320 x 1989-2194	905	905	905	986	782



<sup>1</sup> No fitting clearance allowed.

<sup>2</sup> Windows for Beaumont: Standard , Diamond , Cross . Please state on order if plain or crystal panes.

<sup>4</sup> Only available from 755 mm wide. Overall frame size is 875 mm wide for Cathedral, Beaumont and Georgian only.

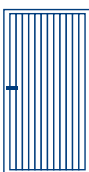
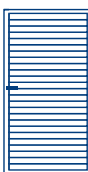
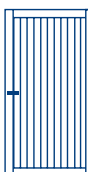

All doors come factory pre-framed, right hand hinged with the handle on the left as standard (viewed from outside).  
Supplied with lever/lever handle set. Doors only available to open outwards.

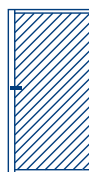
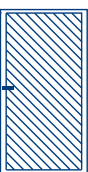
### Timber door - standard sizes

Nominal Door Size Width x Height (mm x mm)	Overall frame size (between fix) <sup>1</sup> Width x Height (mm x mm)	Size Code						
			Vertical Cedar	Horizontal Cedar	Kingsbury	Seymour	Half Chevron (Left)	Half Chevron (Right)
762 x 1931	882 x 1989	2664	1241	1271	1349	1241	1487	1487
762 x 1981	882 x 2039	2666	1257	1286	1361	1257	1500	1500
762 x 2136	882 x 2194	2670	1278	1305	1382	1278	1522	1522
914 x 1931	1034 x 1989	3064	1286	1312	1388	1286	1528	1528
914 x 1981	1034 x 2039	3066	1298	1326	1404	1298	1542	1542
914 x 2136	1034 x 2194	3070	1319	1349	1423	1319	1563	1563
1067 x 1931	1187 x 1989	3664	1326	1354	1433	1326	1571	1571
1067 x 1981	1187 x 2039	3666	1340	1369	1445	1340	1583	1583
1067 x 2134	1187 x 2194	3670	1361	1388	1465	1361	1605	1605
1209 x 1931	1320 x 1989	4064	1369	1395	1472	1369	1611	1611
1209 x 1981	1320 x 2039	4066	1382	1411	1487	1382	1627	1627
1209 x 2136	1320 x 2194	4070	1404	1433	1505	1404	1646	1646

<sup>1</sup> No fitting clearance allowed.

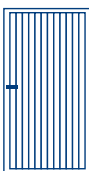
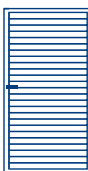
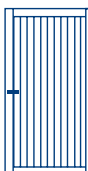
### Timber door - purpose-made sizes

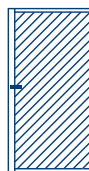
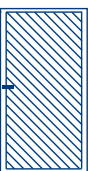
Nominal Door Size Width x Height (mm x mm)	Overall frame size (between fix) <sup>1</sup> Width x Height (mm x mm)						
		Vertical Cedar	Horizontal Cedar	Kingsbury <sup>2</sup>	Seymour	Half Chevron (Left)	Half Chevron (Right)
700-1066 x 1931-2136	820-1186 x 1989-2194	1500	1528	1605	1500	1743	1743
2067-1209 x 1931-2136	1187-1320 x 1989-2194	1583	1611	1689	1583	1827	1827

<sup>1</sup> No fitting clearance allowed.

<sup>2</sup> Minimum overall frame width for Kingsbury is 826 mm.

# Steel, Timber and GRP Side-hinged Doors

## Surface

Steel Side-hinged doors are constructed around a strong steel box section chassis in Traffic White (RAL 9016) as standard. Timber doors constructed using solid red cedar, built around our steel box section chassis. A range of stain options are available. All Garador timber side-hinged garage doors are plywood backed, the timber boards are not visible from the inside of the garage door.

## Pre-Framed

All doors come factory pre-framed, right-hand door leaf leading as standard (viewed from the outside) with lever/ lever handle set.

## Door Stays

Door stays are recommended in windy conditions.

## Steel Colours

Standard colours are:

- Terra Brown (RAL 8028)
- Traffic White (RAL 9016)

Optional colours available on an approximate 4 week lead-time:

- Light Ivory (RAL 1015)
- Pigeon Blue (RAL 5014)
- Anthracite Grey (RAL 7016)
- Burgundy Brown
- Ruby Red (RAL 3003)
- Moss Green (RAL 6005)
- Jet Black (RAL 9005)
- Golden Brown
- Signal Blue (RAL 5005)
- Fir Green (RAL 6009)
- Slate Grey (RAL 7015)
- Chartwell Green (BS 4800)
- Steel Blue (RAL 5011)

Other optional colours available on an approximate 6 week lead-time:

- Stone Grey (RAL 7030)
- Light grey (RAL 7035)
- Window Grey (RAL 7040)
- Clay Brown (RAL 8003)

## Timber Stains

Full finished stains available as an option. Stain colours include Light Oak, Antique Oak, Mahogany, Walnut, Chestnut and Ebony

## GRP Colours

White, Magnolia, Bleached Oak, Red Mahogany, Dark Mahogany, Light Oak, Dark Oak, Irish Oak, Honey Beech, Teak, Rosewood, Golden Brown, Ebony, Anthracite Grey, Green, Blue, Gloss White and Gloss Magnolia.

## Handle

Supplied with black lever/lever handle on right side (viewed outside)

## Terminology

Nominal Door Size: This is the actual door panel size plus the fitting tolerances. The nominal door size should be used for internal dimensions of a timber frame.

Size Code: This has traditionally been used to order doors. This may not be the actual door size.

## Packaging

All steel side-hinged doors are poly-wrapped as standard.

## Stock Availability

4 to 6 week lead-time on standard and purpose made sizes.





### New product development

Due to on-going product development, side-hinged door prices maybe subject to future change.

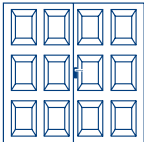
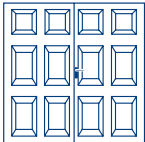
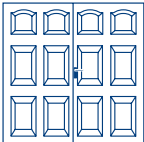
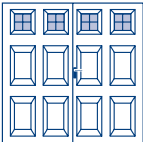
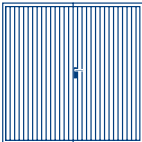
### Steel door - standard sizes

Nominal Door Size Width x Height (mm x mm)	Overall frame size (between fix) <sup>1</sup> Width x Height (mm x mm)	Size Code					
			Georgian	Beaumont	Cathedral	Beaumont with Windows <sup>2</sup>	Carlton
1810 x 1830	1930 x 1890	6060	-	-	-	-	1110
1964 x 1830	2084 x 1890	6660	-	-	-	-	1132
1964 x 1931	2084 x 1991	6664	-	-	-	-	1156
1964 x 1981	2084 x 2041	6666	-	-	-	-	1156
1964 x 2136	2084 x 2196	6670	-	-	-	-	1181
2114 x 1830	2234 x 1890	7060	-	-	-	-	1181
2114 x 1931	2234 x 1991	7064	1296	1296	1296	1605	1204
2114 x 1981	2234 x 2041	7066	<b>1296</b>	1296	1296	1605	<b>1204</b>
2114 x 2136	2234 x 2196	7070	1320	1320	1320	1628	<b>1228</b>
2239 x 1931	2359 x 1991	7564	1367	1367	1367	1677	1276
2239 x 1981	2359 x 2041	7566	1367	1367	1367	1677	1276
2239 x 2136	2359 x 2196	7570	1392	1392	1392	1704	1296
2264 x 1931	2384 x 1991	7664	1392	1392	1392	1704	1296
2264 x 1981	2384 x 2041	7666	1392	1392	1392	1704	1296
2264 x 2136	2384 x 2196	7670	1414	1414	1414	1723	1320
2419 x 1931	2539 x 1991	8064	1463	1463	1463	1772	1367
2419 x 1981	2539 x 2041	8066	1463	1463	1463	1772	1367
2419 x 2136	2539 x 2196	8070	1485	1485	1485	1796	1392

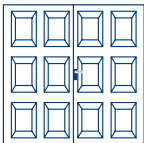
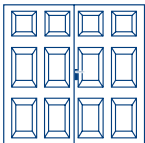
### Steel door - purpose-made sizes

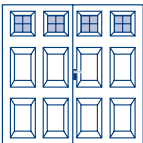
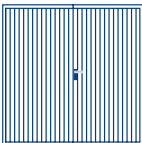
Overall frame size (between fix) <sup>1</sup> Width x Height (mm x mm)					
	Georgian	Beaumont	Cathedral	Beaumont with Windows <sup>2</sup>	Carlton
1930 - 2234 x 1890 - 2041	-	-	-	-	1288
1930 - 2234 x 2042 - 2196	-	-	-	-	1327
2235 - 2384 x 1890 - 1990	-	-	-	-	1345
2235 - 2384 x 1991 - 2041	1474	1474	1474	1783	1392
2235 - 2384 x 2042 - 2196	1490	1490	1490	1801	1423
2385 - 2539 x 1890 - 1990	-	-	-	-	1410
2385 - 2539 x 1991 - 2041	1568	1568	1568	1876	1472
2385 - 2539 x 2042 - 2196	1588	1588	1588	1899	1492

<sup>1</sup> No fitting clearance allowed.

<sup>2</sup> Windows for Beaumont: Standard , Diamond , Cross . Please state on order if plain or crystal panes.

All doors come factory pre-framed, right hand door leaf leading as standard (viewed from the outside) with lever/lever handle set. Door stays are recommended in windy locations.

The above doors are shown as 50/50 door leaves configuration.

Up to 2234 mm overall frame width these doors are also available as a 1/3 2/3 door configuration.

Prices are the same but please be aware panel configurations on Georgian, Beaumont & Cathedral doors will have 3 pressing columns with increased spacing between the pressing (1/3 2/3 is a term used to describe these doors but please note the 1/3 door leaf is always 800 mm wide with the 2/3 element varying to make the desired overall width). 1/3 leaf is always leading.

**Timber door - standard sizes**

Nominal Door Size Width x Height (mm x mm)	Overall frame size (between fix) <sup>1</sup> Width x Height (mm x mm)	Size Code					
			Vertical Cedar <sup>2</sup>	Horizontal Cedar <sup>2</sup>	Kingsbury <sup>3</sup>	Seymour <sup>3</sup>	Tudor <sup>3</sup>
1810 x 1830	1930 x 1890	6060	1925	1968	2177	1813	1813
1964 x 1830	2084 x 1890	6660	1952	1999	2177	1841	1841
1964 x 1931	2084 x 1991	6664	1952	1999	2177	1841	1841
1964 x 1981	2084 x 2041	6666	1973	2019	2184	1863	1863
1964 x 2136	2084 x 2196	6670	1973	2019	2212	1863	1863
2114 x 1830	2234 x 1890	7060	2009	2053	2212	1897	1897
2114 x 1931	2234 x 1991	7064	2016	2061	2230	1904	1904
2114 x 1981	2234 x 2041	7066	2024	2068	2259	1910	1910
2114 x 2136	2234 x 2196	7070	2024	2068	2274	1910	1910
2239 x 1931	2359 x 1991	7564	2043	2090	2350	1934	1934
2239 x 1981	2359 x 2041	7566	2049	2097	2365	1940	1940
2239 x 2136	2359 x 2196	7570	2064	2109	2413	1952	1952
2264 x 1931	2384 x 1991	7664	2043	2090	2357	1934	1934
2264 x 1981	2384 x 2041	7666	2049	2097	2390	1940	1940
2264 x 2136	2384 x 2196	7670	2064	2109	2442	1952	1952
2419 x 1931	2539 x 1991	8064	2134	2180	2594	2024	2024
2419 x 1981	2539 x 2041	8066	2140	2187	2608	2030	2030
2419 x 2136	2539 x 2196	8070	2149	2192	2685	2036	2036

**Timber door - standard sizes**

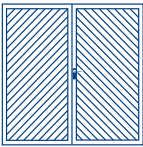
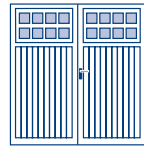
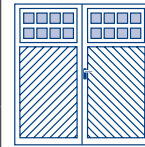
Nominal Door Size Width x Height (mm x mm)	Overall frame size (between fix) <sup>1</sup> Width x Height (mm x mm)	Size Code			
			Chevron Cedar <sup>3</sup>	Ashton <sup>3,4</sup>	Ashton Chevron <sup>3,4</sup>
1810 x 1830	1930 x 1890	6060	2177	2357	2475
1964 x 1830	2084 x 1890	6660	2177	2357	2475
1964 x 1931	2084 x 1991	6664	2177	2357	2475
1964 x 1981	2084 x 2041	6666	2184	2365	2481
1964 x 2136	2084 x 2196	6670	2212	2390	2511
2114 x 1830	2234 x 1890	7060	2212	2390	2511
2114 x 1931	2234 x 1991	7064	2230	2413	2531
2114 x 1981	2234 x 2041	7066	2259	2442	2558
2114 x 2136	2234 x 2196	7070	2274	2453	2573
2239 x 1931	2359 x 1991	7564	2350	2531	2649
2239 x 1981	2359 x 2041	7566	2365	2544	2665
2239 x 2136	2359 x 2196	7570	2413	2594	2713
2264 x 1931	2384 x 1991	7664	2357	2537	2657
2264 x 1981	2384 x 2041	7666	2390	2573	2691
2264 x 2136	2384 x 2196	7670	2442	2620	2742
2419 x 1931	2539 x 1991	8064	2594	2775	2894
2419 x 1981	2539 x 2041	8066	2608	2788	2908
2419 x 2136	2539 x 2196	8070	2685	2865	2984

### Timber door - purpose-made sizes

Overall frame size  
(between fix)<sup>1</sup>  
Width x Height  
(mm x mm)

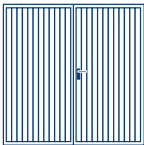
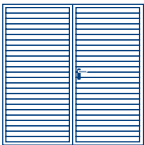
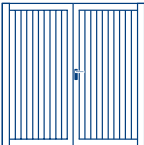
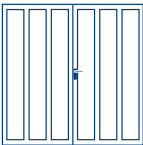
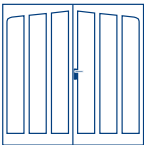

	 Vertical Cedar <sup>2</sup>	 Horizontal Cedar <sup>2</sup>	 Kingsbury <sup>3</sup>	 Seymour <sup>3</sup>	 Tudor <sup>3</sup>
1930 - 2234 x 1890 - 2041	2063	2109	2301	1960	1960
1930 - 2234 x 2042 - 2196	2109	2156	2349	2007	2007
2235 - 2384 x 1890 - 2041	2156	2207	2398	2054	2054
2235 - 2384 x 2042 - 2196	2218	2266	2582	2117	2117
2385 - 2539 x 1890 - 2041	2349	2398	2718	2247	2247
2385 - 2539 x 2042 - 2196	2389	2439	2761	2287	2287

<sup>1</sup> No fitting clearance allowed.

<sup>2</sup> On doors with windows, please state on order if plain or crystal panes.

### Timber door - purpose-made sizes

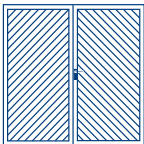
Overall frame size  
(between fix)<sup>1</sup>  
Width x Height  
(mm x mm)

	 Chevron Cedar <sup>3</sup>	 Ashton <sup>3,4</sup>	 Ashton Chevron <sup>3,4</sup>
1930 - 2234 x 1890 - 2041	2301	2478	2595
1930 - 2234 x 2042 - 2196	2349	2528	2643
2235 - 2384 x 1890 - 2041	2398	2574	2691
2235 - 2384 x 2042 - 2196	2582	2769	2890
2385 - 2539 x 1890 - 2041	2718	2906	3028
2385 - 2539 x 2042 - 2196	2761	2948	3071

<sup>1</sup> No fitting clearance allowed.



<sup>2</sup> The above doors are shown as 50/50 door leaves configuration. Up to 2234 mm overall frame width these doors are also available as a 1/3 2/3 door configuration on Vertical Cedar and Horizontal Cedar doors.

Prices are the same but please be aware panel configurations may be different from those shown above (1/3 2/3 is a term used to describe these doors but please note the 1/3 door leaf is always 800 mm wide with the 2/3 element varying to make the desired overall width). 1/3 leaf is always leading.

<sup>3</sup> Not available in 70/30 configuration. Only Vertical Cedar and Horizontal Cedar Side Hinged doors are available in 70/30 configuration up to 7'0" wide.

<sup>4</sup> On doors with windows, please state on order if plain or crystal panes.

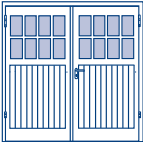
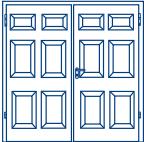
**GRP door -  
standard sizes**

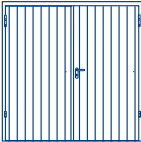
Nominal Door Size (between fix) <sup>1</sup> Width x Height (mm x mm)	Overall frame size (between fix) <sup>1</sup> Width x Height (mm x mm)	Size Code				
			Dorchester <sup>2</sup>	Kenmore	Arden	Somerset <sup>3</sup>
1810 x 1830	1930 x 1890	6060	-	-	-	2399
1964 x 1830	2084 x 1890	6660	-	-	-	2399
1964 x 1931	2084 x 1991	6664	-	-	-	2399
1964 x 1981	2084 x 2041	6666	-	-	-	2399
1964 x 2136	2084 x 2196	6670	-	-	-	2399
2114 x 1830	2234 x 1890	7060	-	-	-	2433
2114 x 1931	2234 x 1991	7064	2433	2433	2433	2433
2114 x 1981	2234 x 2041	7066	2469	2469	2469	2469
2114 x 2136	2234 x 2196	7070	2469	2469	2469	2469
2239 x 1931	2359 x 1991	7564	2557	2557	2557	2557
2239 x 1981	2359 x 2041	7566	2557	2557	2557	2557
2239 x 2136	2359 x 2196	7570	2557	2557	2557	2557
2264 x 1931	2384 x 1991	7664	2557	2557	2557	2557
2264 x 1981	2384 x 2041	7666	2557	2557	2557	2557
2264 x 2136	2384 x 2196	7670	2557	2557	2557	2557
2419 x 1931	2539 x 1991	8064	2645	2645	2645	2645
2419 x 1981	2539 x 2041	8066	2645	2645	2645	2645
2419 x 2136	2539 x 2196	8070	2645	2645	2645	2645

**GRP door -  
purpose-made sizes**

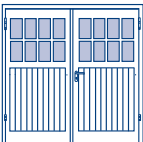
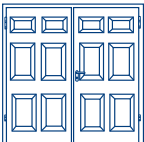
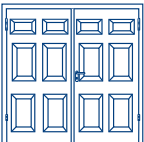
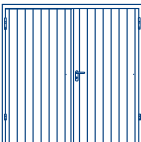
Overall frame size (between fix) <sup>1</sup> Width x Height (mm x mm)				
	Dorchester <sup>2</sup>	Kenmore	Arden	Somerset <sup>3</sup>
1930 - 2234 x 1890 - 2041	-	-	-	2879
1930 - 2234 x 2042 - 2196	-	-	-	2939
2235 - 2384 x 1890 - 2041 <sup>1</sup>	2998	2998	2998	2998
2235 - 2384 x 2042 - 2196	3059	3059	3059	3059
2385 - 2539 x 1890 - 2041	3118	3118	3118	3118
2385 - 2539 x 2042 - 2196	3174	3174	3174	3174

<sup>1</sup> Please note Dorchester, Kenmore and Arden side-hinged garage doors have a minimum overall frame size of 2234 mm x 1980 mm.

<sup>2</sup> For Dorchester side-hinged garage doors, only clear glazing or stippled glazing available for windows.

<sup>3</sup> The Somerset GRP side-hinged garage door is also available in a 70/30 configuration. All other GRP side-hinged garage doors are only available in 50/50 configuration.



Options	Steel		Timber		GRP	
	Garage side doors	Side-hinged doors	Garage side doors	Side-hinged doors	Garage side doors	Side-hinged doors
	add	add	add	add	add	add
For powder-coated steel doors <sup>1</sup> : - Terra Brown (RAL 8028)	30	38	-	-	-	-
For powder-coated steel doors <sup>1</sup> : - Moss Green (RAL 6005) - Ruby Red (RAL 3003) - Signal Blue (RAL 5005) - Jet Black (RAL 9005) - Steel Blue (RAL 5011) - Light Ivory (RAL 1015) - Pigeon Blue (RAL 5014) - Fir Green (RAL 6009) - Anthracite Grey (RAL 7016) - Stone Grey (RAL 7030) - Light Grey (RAL 7035) - Slate Grey (RAL 7015) - Clay Brown (RAL 8003) - Window Grey (RAL 7040) - Chartwell Green (BS 4800) - Burgundy Brown - Golden Oak (solid)	95	123	-	-	-	-
Surcharge for Premium GRP colours: - Green - Blue	-	-	-	-	-	577
Door stays (pair)	-	76	-	76	-	76
Handles for steel and timber doors: - knob/lever black plastic	30	30	30	30	-	-
For timber doors: factory fully finished in - Light Oak - Antique Oak - Mahogany - Walnut - Chestnut - Ebony	-	-	93	141	-	-
Factory white primer ready for on-site painting	-	-	156	192	-	-
Factory fully finished painting (any RAL colour)	-	-	259	323	-	-
Anodised Aluminium lever/lever handles: - white	117	117	117	117	-	117
Anodised Aluminium lever/lever handles: - chrome effect	145	145	145	145	-	145
Left hand hinged	84	84	84	84	-	84

<sup>1</sup> Coloured Beaumont with windows doors are supplied with white or brown window frames as standard (for colour window frames see page 13).

For timber side-hinged doors chassis is either Traffic White (RAL 9016) or Terra Brown (RAL 8028) regardless of exact colour of timber finishing, except when Ebony finishing is ordered and then the chassis will be supplied in black.

# Steel Panel Doors - Specifications

## Canopy Gear Specifications

The canopy gear allows the door to travel in vertical tracks and is counterbalanced by an overhead torsion spring. The nominal drive through is 40 mm less than the opening width and 130 mm less than the opening height.

In the open position, the door projects approximately one third of the door height, forming a canopy.

For doors fitted with an operator, please observe operator specifications.

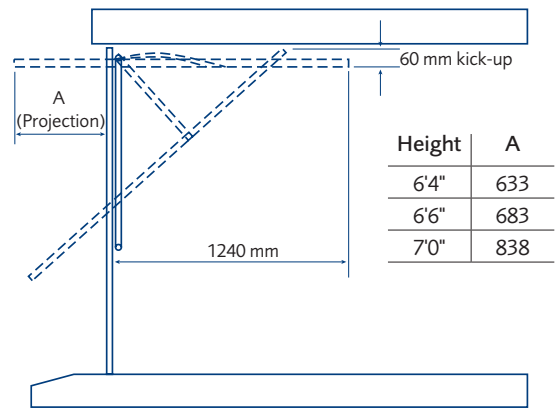

## On-site timber frame

### Behind brickwork fixing

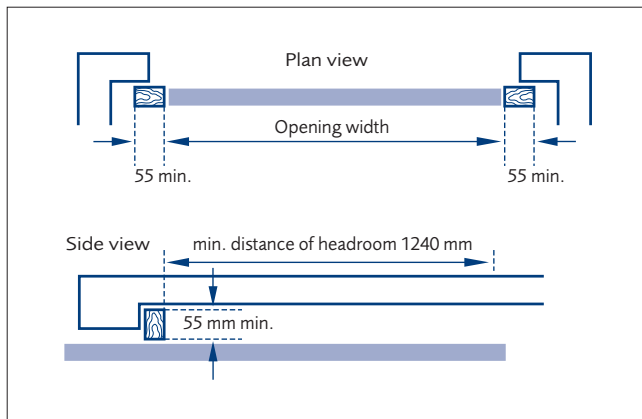

### Between brickwork fixing

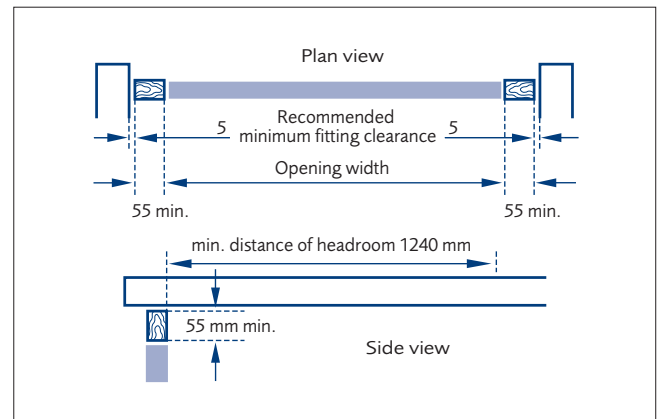

## Factory pre-framed with steel box frame

The garage door is supplied factory fitted to a steel box section frame and is secured to the brickwork by using just 7 fixings.

### Behind brickwork fixing

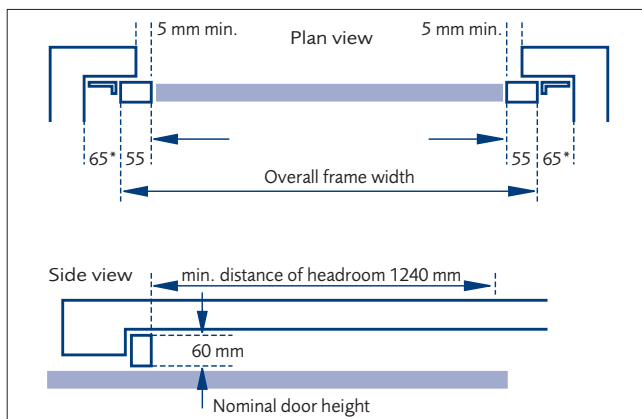

### Between brickwork fixing

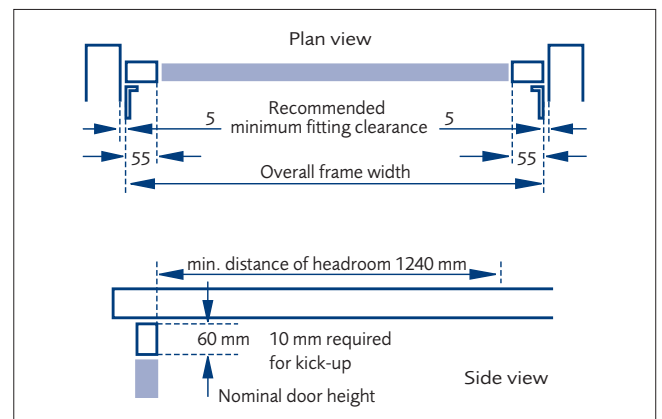

\* width of anchor brackets in this position

## Up & Over Garage Door Steel Frame Dimensions

	Width	Depth
Canopy steel frame (single door)	60 mm	40 mm
Retractable steel frame (single door)	75 mm	40 mm
Retractable steel frame (double door)	75 mm	80 mm

## Single & Double Retractable Gear Specifications

The retractable gear allows the door to be retracted inside the garage when open by means of horizontal overhead tracks supported by wall or ceiling mounted suspension brackets. This gear is available as an option for single doors and comes as standard with double garage doors.

The nominal drive through clearance is 105 mm less than the opening width and 110 mm less than the opening height for single doors and 140 mm less than the opening height for double doors.

For doors fitted with an operator, please observe operator specifications.

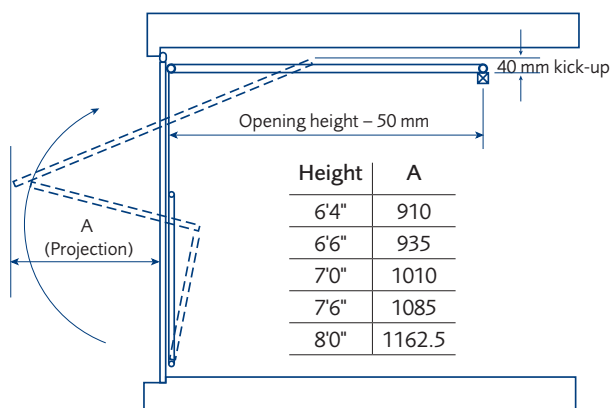

### On-site timber frame

#### Behind brickwork fixing

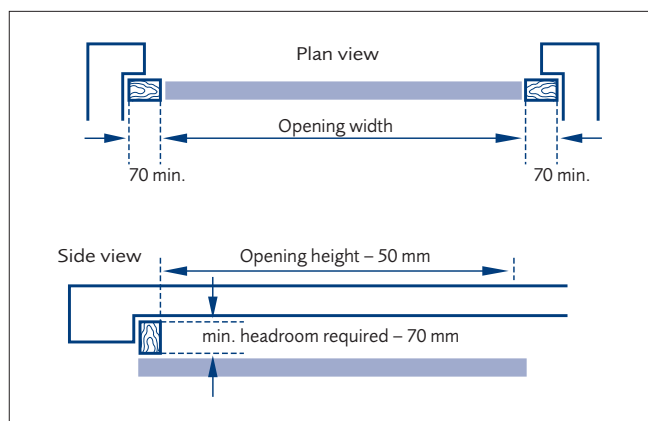

#### Between brickwork fixing

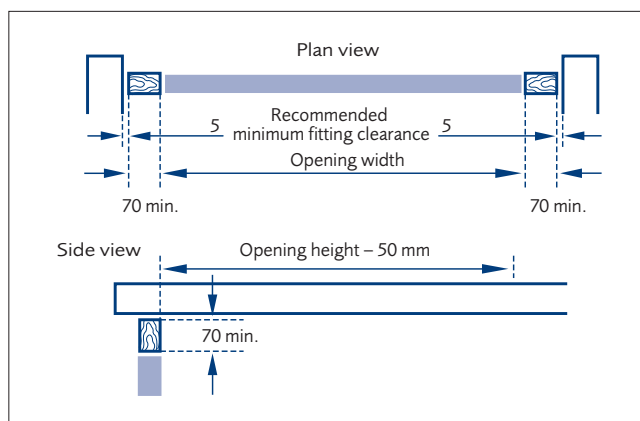

### Factory pre-framed with steel box frame

The garage door is supplied factory fitted to a steel box section frame and is secured to the brickwork by using just 7 fixings.

#### Behind brickwork fixing

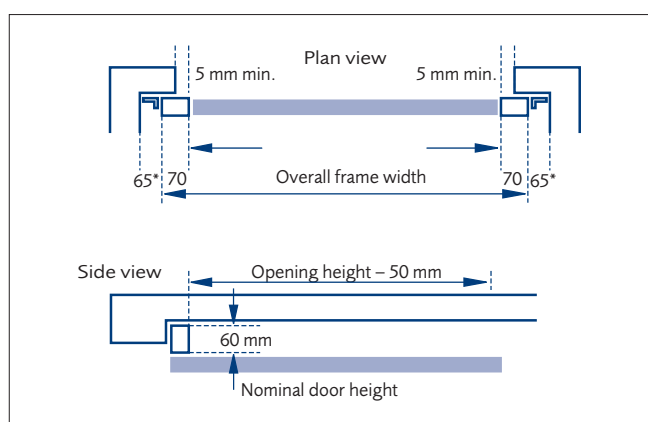

\* width of anchor brackets in this position

#### Between brickwork fixing

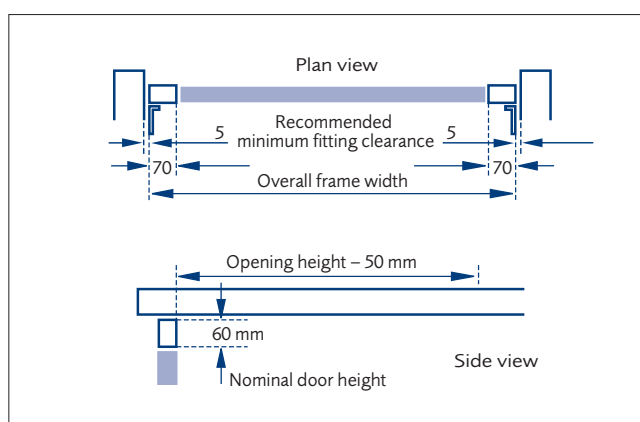

### Retractable Plus Gear

For any door up to a width of 2744 mm in any of the three standard heights Retractable Plus Gear is available. This gear type creates clear drive through width at the crucial wing mirror height.

Door height	Clear height below lifting arms
7'0"	1260
6'6"	1105
6'4"	1055

## Garage Side Door & Side-hinged Door Specifications

Door leaves supplied factory pre-framed ready for site installation. Fixed leaf (RH side when viewed from inside) fitted with tower bolts at top and bottom of inner leading edge. The floor will need to be finished and level for the bottom tower bolts to engage.

### Garage Side door factory pre-framed

#### Behind brickwork fixing

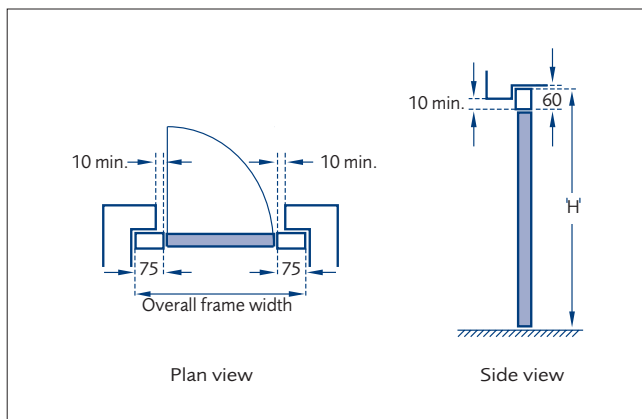

#### Between brickwork fixing

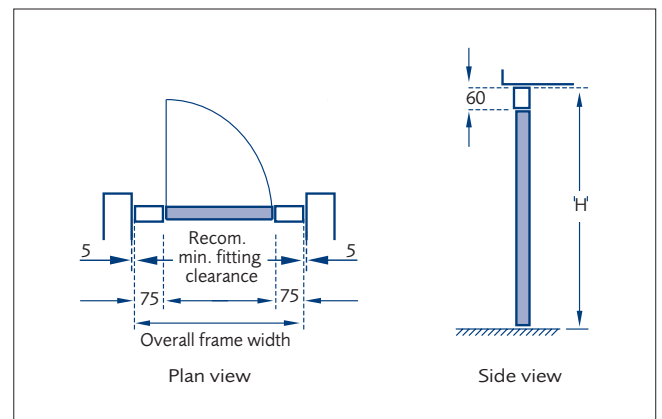

The nominal clear passage clearance is 74 mm less than the opening width and 12 mm less than the opening height.

### Side-hinged door factory pre-framed

#### Behind brickwork fixing

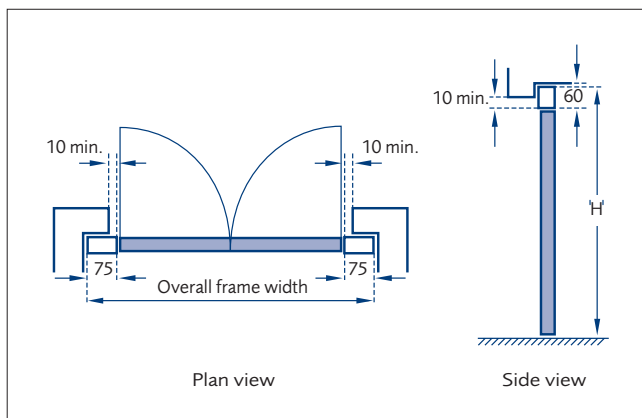

#### Between brickwork fixing

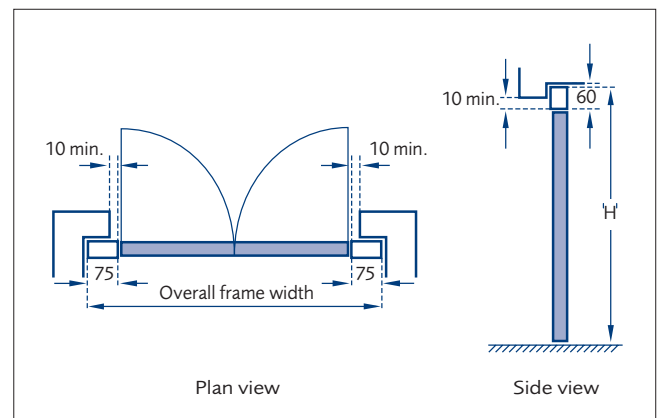

The nominal drive through clearance is 124 mm less than the opening width and 12 mm less than the opening height.

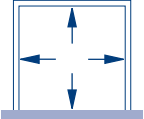
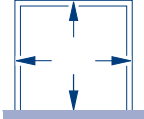
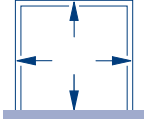
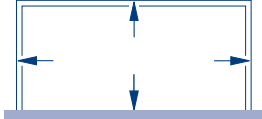

## Frame Dimensions for Panel Doors

Size Code				
	Internal frame size On-site timber frame Width x Height (mm x mm)	Pre-framed canopy door overall frame sizes shown <sup>1</sup> Width x Height (mm x mm)	Pre-framed retractable door overall frame sizes shown <sup>1</sup> Width x Height (mm x mm)	Frame kit for double door overall frame sizes shown <sup>1</sup> Width x Height (mm x mm)
6660	1984 x 1830	2094 x 1888	2124 x 1888	-
6663	1984 x 1905	2094 x 1963	2124 x 1963	-
6664	1984 x 1931	2094 x 1989	2124 x 1989	-
6666	1984 x 1981	2094 x 2039	2124 x 2039	-
6670	1984 x 2136	2094 x 2194	2124 x 2194	-
61064	2084 x 1931	2194 x 1989	2224 x 1989	-
61066	2084 x 1981	2194 x 2039	2224 x 2039	-
61070	2084 x 2136	2194 x 2194	2224 x 2194	-
7060	2134 x 1830	2244 x 1888	2274 x 1888	-
7063	2134 x 1905	2244 x 1963	2274 x 1963	-
7064	2134 x 1931	2244 x 1989	2274 x 1989	-
7066	2134 x 1981	2244 x 2039	2274 x 2039	-
7068	2134 x 2036	2244 x 2094	2274 x 2094	-
7070	2134 x 2136	2244 x 2194	2274 x 2194	-
7072	2134 x 2186	-	2274 x 2244	-
7076	2134 x 2286	-	2274 x 2344	-
7163	2170 x 1905	2280 x 1963	2310 x 1963	-
7164	2170 x 1931	2280 x 1989	2310 x 1989	-
7166	2170 x 1981	2280 x 2039	2310 x 2039	-
7168	2170 x 2036	2280 x 2094	2310 x 2094	-
7170	2170 x 2136	2280 x 2194	2310 x 2194	-
7172	2170 x 2186	-	2310 x 2244	-
7176	2170 x 2286	-	2310 x 2344	-
7364	2224 x 1931	2334 x 1989	2364 x 1989	-
7366	2224 x 1981	2334 x 2039	2364 x 2039	-
7370	2224 x 2136	2334 x 2194	2364 x 2194	-
7563	2259 x 1905	2369 x 1963	2399 x 1963	-
7564	2259 x 1931	2369 x 1989	2399 x 1989	-
7566	2259 x 1981	2369 x 2039	2399 x 2039	-
7568	2259 x 2036	2369 x 2094	2399 x 2094	-
7570	2259 x 2136	2369 x 2194	2399 x 2194	-
7572	2259 x 2186	-	2399 x 2244	-
7576	2259 x 2286	-	2399 x 2344	-
7663	2284 x 1905	2394 x 1963	2424 x 1963	-
7664	2284 x 1931	2394 x 1989	2424 x 1989	-
7666	2284 x 1981	2394 x 2039	2424 x 2039	-
7668	2284 x 2036	2394 x 2094	2424 x 2094	-
7670	2284 x 2136	2394 x 2194	2424 x 2194	-
7672	2284 x 2186	-	2424 x 2244	-
7676	2284 x 2286	-	2424 x 2344	-
8063	2439 x 1905	2549 x 1963	2579 x 1963	-
8064	2439 x 1931	2549 x 1989	2579 x 1989	-
8066	2439 x 1981	2549 x 2039	2579 x 2039	-
8068	2439 x 2036	2549 x 2094	2579 x 2094	-
8070	2439 x 2136	2549 x 2194	2579 x 2194	-
8072	2439 x 2186	-	2579 x 2244	-

<sup>1</sup> No fitting clearance allowed. If door is fitted between the brickwork a minimum of 10 mm clearance over the width and 5 mm over the height should be added to the overall frame size when selecting the door.

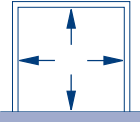
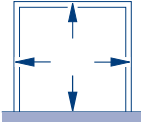
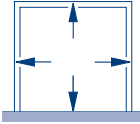
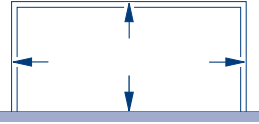
Size Code				
	Internal frame size On-site timber frame Width x Height (mm x mm)	Pre-framed canopy door overall frame sizes shown <sup>1</sup> Width x Height (mm x mm)	Pre-framed retractable door overall frame sizes shown <sup>1</sup> Width x Height (mm x mm)	Frame kit for double door overall frame sizes shown <sup>1</sup> Width x Height (mm x mm)
8076	2439 x 2286	–	2579 x 2344	–
8666	2590 x 1981	–	2730 x 2039	–
8670	2590 x 2136	–	2730 x 2194	–
8676	2590 x 2286	–	2730 x 2344	–
9066	2744 x 1981	–	2884 x 2039	–
9070	2744 x 2136	–	2884 x 2194	–
9076	2744 x 2286	–	2884 x 2344	–
1066	3049 x 1981	–	3189 x 2039	–
1070	3049 x 2136	–	3189 x 2194	–
1076	3049 x 2286	–	–	3189 x 2344
1166	3354 x 1981	–	–	3494 x 2039
1170	3354 x 2136	–	–	3494 x 2194
1176	3354 x 2286	–	–	3494 x 2344
1266	3659 x 1981	–	–	3799 x 2039
1270	3659 x 2136	–	–	3799 x 2194
1276	3659 x 2286	–	–	3799 x 2344
1366	3964 x 1981	–	–	4104 x 2039
1370	3964 x 2136	–	–	4104 x 2194
1376	3964 x 2286	–	–	4104 x 2344
1466	4269 x 1981	–	–	4409 x 2039
1470	4269 x 2136	–	–	4409 x 2194
1566	4574 x 1981	–	–	4714 x 2039
1570	4574 x 2136	–	–	4714 x 2194
1666	4879 x 1981	–	–	5019 x 2039
1670	4879 x 2136	–	–	5019 x 2194

<sup>1</sup> No fitting clearance allowed. If door is fitted between the brickwork a minimum of 10 mm clearance over the width and 5 mm over the height should be added to the overall frame size when selecting the door.

# Steel Sectional Garage Doors

## Door sections

Made of galvanized steel. Available as Premium (42 mm thick insulated panel) and Classic (single skinned panel) versions. Premium doors are PU-foam insulated (100% CFC-free). Bottom door section comes with floor seal.

## Surface

Outside: Woodgrain embossed, Slategrain, Sandgrain or Silkgrain textures with painted or foil coated finishes.  
Inside: pebble texture.

## Spring arrangement

All doors up to 4000 mm wide (excluding Silkgrain) come with tension springs as standard and torsion springs are available at extra cost. All doors over 4000 mm wide (excluding Silkgrain) come with torsion springs as standard. Low headroom application available at extra cost.

Doors with a Silkgrain surface finish are supplied with tension springs as standard up to 3049 mm wide and torsion springs as standard on doors over 3050 mm wide.

## Side frames & Fascia

Sectional doors are designed to be fitted behind the reveals and side frames are supplied white in colour. Cover profiles are available for use with coloured or foil coated door finishes. A single skin fascia is supplied with all doors which is finished in the same colour as the door sections.

## Colours

Steel Woodgrain and Silkgrain doors can be ordered in almost any colour from the RAL colour chart.

Standard colours are:

- |                          |                              |                          |                              |
|--------------------------|------------------------------|--------------------------|------------------------------|
| - Light Ivory (RAL 1015) | - Slate Grey (RAL 7015)      | - Light Grey (RAL 7035)  | - Jet Black (RAL 9005)       |
| - Moss Green (RAL 6005)  | - Anthracite Grey (RAL 7016) | - Quartz Grey (RAL 7039) | - White Aluminium (RAL 9006) |
| - Fir Green (RAL 6009)   | - Titan Metallic (CH 703)    | - Window Grey (RAL 7040) | - Grey Aluminium (RAL 9007)  |
| - Basalt Grey (RAL 7012) | - Stone Grey (RAL 7030)      | - Terra Brown (RAL 8028) |                              |

Special RAL colours are:

- |                         |                          |                             |                             |
|-------------------------|--------------------------|-----------------------------|-----------------------------|
| - Black Red (RAL 3007)  | - Black Grey (RAL 7021)  | - Signal Black (RAL 9004)   | - Traffic Black (RAL 9017)  |
| - Black Blue (RAL 5004) | - Black Brown (RAL 8022) | - Graphite Black (RAL 9011) | - Chartwell Green (BS 4800) |

Non standard RAL colours are:

Based on full RAL colour chart excluding Traffic Purple (RAL 4006), Purple Violet (RAL 4007) and pearlescent or florescent options.

Timber effect foil coated doors are available in the following five finishes:

Golden Oak, Dark Oak, Night Oak, Rosewood and Winchester Oak. Only Golden Oak and Rosewood surface finishes are kept as stock door sizes (prices highlighted in bold) for timber effect sectional garage doors. Dark Oak, Night Oak and Winchester Oak surface finishes are not stocked, but are made to order.

Foil coated finish also available in Titan Metallic (CH 703)

## Handle

Sectional doors in shaded boxes are generally supplied ex-works for automatic operation, i.e. without handle hole and lock. Factory-fitted handle and lock are available with an increased lead-time. All other doors are on a 4 to 6 week lead-time. For electrical operation of a garage with no other personal access, an emergency release kit must be fitted.

## Packaging

Sectional doors are provided in a palletted format shrink wrapped for easy handling.

## Stock availability

Popular sectional doors are generally ex-stock in Traffic White (RAL 9016) and Terra Brown (RAL 8028) in some sizes, other sizes and colour options require up to 6 weeks lead-time. Contact sales office for further details.

## Gears

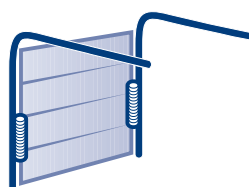

Tension spring

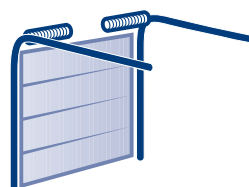

Torsion spring

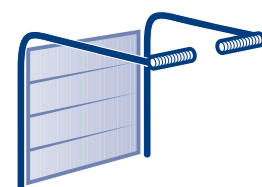

Low headroom torsion spring fitting



## Window options

### Georgian design

Prices £ stated per window  
Window frames white as standard

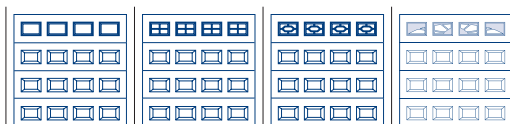

	Standard	Cross	Diamond	Sunrise
Premium - Woodgrain <sup>1</sup>	109	133	133	137
Classic - Woodgrain <sup>1</sup>	102	122	122	129
Premium - Timber effect <sup>2</sup>	137	162	162	173

### Linear small design

Prices £ stated per window  
Window frames white as standard

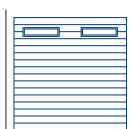

	Linear 1
Premium - Woodgrain <sup>1</sup>	109
Classic - Woodgrain <sup>1</sup>	93

### Linear medium design

Prices £ stated per window  
Window frames white as standard



	Standard	Cross	Diamond	Sunrise	Linear 1	Linear 2
Premium - Woodgrain Sandgrain, Silkgrain <sup>1</sup>	109	133	133	137	109	131
Classic - Woodgrain <sup>1</sup>	-	-	-	-	93	-
Premium - Timber effect <sup>2</sup>	137	162	162	173	137	160

### Linear large design

Prices £ stated per window  
Window frames white as standard



	Standard	Cross	Diamond	Sunrise	Linear 1	Linear 2	Linear 3
Premium - Sandgrain, Silkgrain	109	133	133	137	109	131	169
Premium - Timber effect <sup>2</sup>	137	162	162	173	137	160	198

<sup>1</sup> Colours available at surcharge per window (£ 30 for standard colour, £ 51 for non standard colour, £ 99 for special RAL colour).

<sup>2</sup> Window frames are painted in a colour to best complement the colour of the foil coat (colour incl. in price).

Please note, window frames are painted in a colour to complement the colour of the sectional garage door.

#### Standard, Cross, Diamond and Sunrise (overall frame dimension: 395 mm x 270 mm)

Doors up to 2124 mm wide have 3 windows, 2125 mm to 2749 mm wide have 4 windows, 2750 mm to 3499 mm wide have 5 windows, 3500 mm to 3999 mm wide have 6 windows, 4000 mm to 4749 mm wide have 7 windows and doors of 4750 mm up to 5500 mm wide have 8 windows. Except Classic Georgian panels of 2080 mm wide which have 4 and then 2743 mm wide which have 5. Sunrise windows only available from 2130 mm wide doors up to 5500 mm wide doors.

#### Linear 1 (overall frame dimension: 680 mm x 210 mm)

Doors up to 2499 mm wide have 2 windows, 2500 mm to 3499 mm wide have 3 windows, 3500 mm to 4499 mm wide have 4 windows and doors over 4500 mm wide have 5 windows.

#### Linear 2 (overall frame dimension: 620 mm x 270 mm)

Doors up to 2239 mm wide have 2 windows, 2240 mm to 2969 mm wide have 3 windows, 2970 mm to 3689 mm wide have 4 windows, 3690 mm to 4419 mm wide have 5 windows and doors over 4420 mm have 6 windows.

#### Linear 3 (overall frame dimension: 1004 mm x 270 mm)

Door widths from 2250 mm to 3399 mm have 2 windows, 3400 mm to 4489 mm have 3 windows, 4490 mm to 5499 mm have 4 windows, 5500 mm to 6000 mm have 6 windows.

Please state on order if clear or crystal panes.

Georgian sectional doors under 7 ft wide only have 3 pressings.

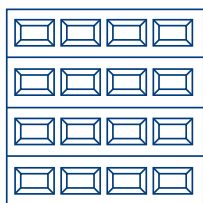

Georgian design

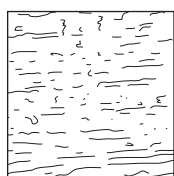

Woodgrain

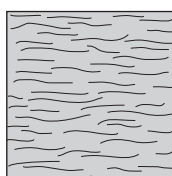

Timber effect

Brickwork opening  
Width x Height  
(mm x mm)

Size Code



Premium

Classic

Premium

Surcharge for Standard Colours

Surcharge for Non-Std. Colours

Surcharge for Special RAL

Brickwork opening Width x Height (mm x mm)	Size Code	Premium	Classic	Premium	Surcharge for Standard Colours	Surcharge for Non-Std. Colours	Surcharge for Special RAL
2080 x 1875	I 61062	1260	968	1643	196	269	537
2080 x 2000	I 61066	<b>1321</b>	-	1681	209	288	573
2080 x 2080	I 610610	<b>1334</b>	<b>1004</b>	-	218	298	595
2134 x 2000	I 7066	<b>1365</b>	<b>986</b>	<b>1681</b>	214	295	588
2134 x 2125	I 7070	<b>1382</b>	<b>1004</b>	<b>1699</b>	227	313	624
2250 x 1875	M 7462	1401	1021	1741	212	292	581
2250 x 2000	M 7466	1442	1044	1772	226	311	620
2250 x 2125	M 7470	1444	1045	1771	239	329	659
2286 x 2000	I 7666	<b>1365</b>	<b>986</b>	<b>1681</b>	230	316	630
2286 x 2125	I 7670	<b>1382</b>	<b>1004</b>	<b>1699</b>	244	334	668
2286 x 2250	I 7674	<b>1380</b>	<b>1045</b>	1853	258	355	708
2286 x 2375	I 7679	1474	1206	1896	271	375	747
2286 x 2500	I 7682	<b>1470</b>	<b>1200</b>	1963	287	393	786
2375 x 1875	M 7962	1401	1021	1741	223	307	613
2375 x 2000	M 7966	1406	1028	1745	238	328	654
2375 x 2125	M 7970	1406	1029	1745	253	349	695
2375 x 2250	M 7974	1470	1064	1801	267	368	736
2438 x 2000	I 8066	<b>1441</b>	<b>1022</b>	1782	244	335	672
2438 x 2125	I 8070	<b>1460</b>	<b>1041</b>	<b>1806</b>	260	357	713
2438 x 2250	I 8074	<b>1454</b>	1085	2036	274	379	754
2438 x 2375	I 8079	1549	1240	2066	291	400	798
2438 x 2500	I 8082	1545	1239	2105	304	420	839
2500 x 1875	M 8262	1401	1021	1741	235	324	645
2500 x 2000	M 8266	1406	1028	1745	251	346	689
2500 x 2125	M 8270	1406	1029	1745	266	365	731
2500 x 2250	M 8274	1470	1064	1801	282	388	775
2500 x 2375	M 8279	1541	1186	1887	297	409	816
2500 x 2500	M 8282	1541	1188	1887	313	432	861
2500 x 2750	M 8290	1670	1312	-	345	473	947
2591 x 2000	I 8666	1441	1022	1782	260	357	714
2591 x 2125	I 8670	<b>1460</b>	<b>1041</b>	1806	277	380	758
2625 x 2125	M 8770	1521	1143	2067	280	385	768
2740 x 2000	I 9066	1565	1185	1954	274	379	754
2740 x 2125	I 9070	<b>1587</b>	<b>1207</b>	1986	292	402	802
2750 x 2000	M 9166	1696	1214	2039	277	380	757
2750 x 2125	M 9170	1726	1239	2067	293	403	805
2750 x 2250	M 9174	1793	1286	2156	309	426	850
2750 x 2375	M 9179	1808	1314	2205	327	450	899
2750 x 2500	M 9182	1867	1379	2292	345	473	947
2896 x 2000	I 9666	1641	1244	2062	291	400	798
2896 x 2125	I 9670	1672	1262	2096	308	424	846
3000 x 2000	M 91066	1780	1274	2123	300	414	827
3000 x 2125	M 91070	1779	1274	2123	320	439	877
3000 x 2250	M 91074	1835	1366	2344	338	466	929
3000 x 2375	M 91079	1869	1442	2397	357	492	981
3000 x 2500	M 91082	1928	1489	2488	376	517	1032
3000 x 3000	M 910910	2504	1828	3179	450	620	1238
3048 x 2000	I 1066	1576	1244	2062	304	420	839
3048 x 2125	I 1070	<b>1608</b>	1262	2096	324	446	891
3250 x 2000	M 10866	1848	-	2474	326	448	895
3250 x 2125	M 10870	1895	-	2487	347	475	950
3250 x 2250	M 10874	1960	-	2512	365	503	1007
3353 x 2000	I 1166	1879	-	2450	335	463	923
3353 x 2125	I 1170	<b>1912</b>	-	2489	357	492	981

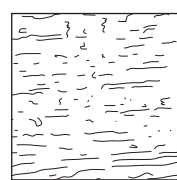
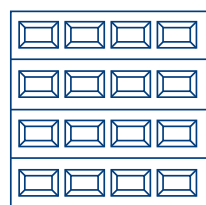

Woodgrain

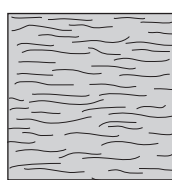

Timber effect

Georgian design

Brickwork opening  
Width x Height  
(mm x mm)

Size Code



Premium

Classic

Premium

Surcharge for Standard Colours

Surcharge for Non-Std. Colours

Surcharge for Special RAL

Brickwork opening Width x Height (mm x mm)	Size Code		Premium	Classic	Premium	Surcharge for Standard Colours	Surcharge for Non-Std. Colours	Surcharge for Special RAL
3500 x 2000	<b>M</b>	11666	2010	-	2656	351	482	963
3500 x 2125	<b>M</b>	11670	2060	-	2719	373	511	1022
3500 x 2250	<b>M</b>	11674	2126	-	2794	393	542	1084
3658 x 2000	<b>I</b>	1266	2213	-	2768	365	504	1007
3658 x 2125	<b>I</b>	1270	<b>2248</b>	-	2815	389	535	1070
3750 x 2000	<b>M</b>	12466	2169	-	2881	376	517	1032
3750 x 2125	<b>M</b>	12470	2225	-	2914	400	548	1095
3750 x 2250	<b>M</b>	12474	2294	-	2985	422	581	1160
3962 x 2000	<b>I</b>	1366	2299	-	2858	396	545	1090
3962 x 2125	<b>I</b>	1370	<b>2331</b>	-	2898	421	580	1157
4000 x 2000	<b>M</b>	13266	2319	-	2903	401	552	1101
4000 x 2125	<b>M</b>	13270	2380	-	2957	425	586	1170
4000 x 2250	<b>M</b>	13274	2455	-	3131	450	620	1238
4250 x 2000	<b>M</b>	131166	2392	-	3030	425	586	1170
4250 x 2125	<b>M</b>	131170	2456	-	3107	451	622	1242
4250 x 2250	<b>M</b>	131174	2534	-	3189	477	659	1316
4267 x 2000	<b>I</b>	1466	<b>2392</b>	-	2945	426	588	1174
4267 x 2125	<b>I</b>	1470	<b>2427</b>	-	<b>2991</b>	453	624	1246
4420 x 2000	<b>I</b>	14666	2478	-	3025	442	608	1215
4420 x 2125	<b>I</b>	14670	<b>2518</b>	-	3072	470	646	1292
4500 x 2000	<b>M</b>	14966	2457	-	3083	450	620	1238
4500 x 2125	<b>M</b>	14970	2526	-	3158	477	659	1316
4500 x 2250	<b>M</b>	14974	2609	-	3253	506	697	1392
4572 x 2000	<b>I</b>	1566	2521	-	3060	457	630	1258
4572 x 2125	<b>I</b>	1570	<b>2564</b>	-	3106	486	668	1335
4725 x 2000	<b>I</b>	15666	2645	-	3120	472	650	1299
4725 x 2125	<b>I</b>	15670	2685	-	3165	502	692	1381
4750 x 2000	<b>M</b>	15766	2640	-	3149	475	654	1306
4750 x 2125	<b>M</b>	15770	2603	-	3216	504	695	1388
4750 x 2250	<b>M</b>	15774	2684	-	3284	534	736	1469
4877 x 2000	<b>I</b>	1666	<b>2645</b>	-	3176	488	672	1341
4877 x 2125	<b>I</b>	1670	<b>2685</b>	-	3226	518	714	1425
5000 x 2000	<b>M</b>	16566	2601	-	3208	500	689	1376
5000 x 2125	<b>M</b>	16570	2660	-	3270	531	731	1461
5000 x 2250	<b>M</b>	16574	2745	-	3536	562	775	1547
5000 x 2375	<b>M</b>	16579	2845	-	3635	593	816	1633
5000 x 2500	<b>M</b>	16582	2837	-	3734	625	861	1719
5500 x 2000	<b>M</b>	18166	2810	-	3398	551	757	1513
5500 x 2125	<b>M</b>	18170	2932	-	3543	585	805	1606
5500 x 2250	<b>M</b>	18174	3100	-	3747	618	850	1701

Purpose-made sizes available upon request. Non standard colours also available upon request. Doors supplied without locking as standard (see options on page 60 for handles). For window options please see page 49.

Prices in bold are generally a stock item. Non-bold prices require a longer lead-time.

- I** Imperial door sizes.
- M** Metric door sizes. Extended lead time of 4-6 weeks.

- Supplied as standard with **tension** spring gear. Torsion spring fitting available for Premium doors at £ 80 surcharge.
- Supplied as standard with **torsion** spring gear. Low headroom fitting available at £ 131 surcharge.

Purpose-made sizes available upon request. Non standard colours also available upon request. Doors supplied without locking as standard (see options on page 60 for handles). For window options please see page 49.

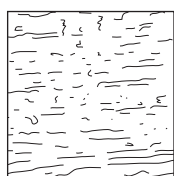
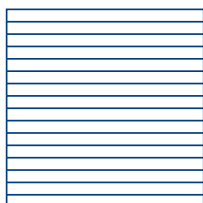

Woodgrain

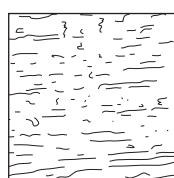
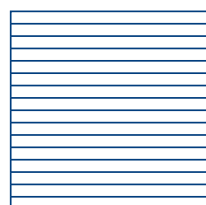

Linear small design

Brickwork opening Width x Height (mm x mm)	Size Code	Premium	Classic <sup>1</sup>	Surcharge for Standard Colours	Surcharge for Non-Std. Colours	Surcharge for Special RAL
2080 x 1875	I 61062	1004	864	196	269	537
2080 x 2000	I 61066	1049	-	209	288	573
2080 x 2080	I 610610	1087	904	218	298	595
2134 x 2000	I 7066	<b>1086</b>	882	214	295	588
2134 x 2125	I 7070	<b>1123</b>	<b>904</b>	227	313	624
2250 x 1875	M 7462	1145	969	212	292	581
2250 x 2000	M 7466	1182	988	226	311	620
2250 x 2125	M 7470	1183	986	239	329	659
2286 x 2000	I 7666	<b>1086</b>	<b>882</b>	230	316	630
2286 x 2125	I 7670	<b>1123</b>	904	244	334	668
2286 x 2250	I 7674	1139	952	258	355	708
2286 x 2375	I 7679	1227	1102	271	375	747
2286 x 2500	I 7682	1224	1100	287	393	786
2375 x 1875	M 7962	1145	969	223	307	613
2375 x 2000	M 7966	1148	971	238	328	654
2375 x 2125	M 7970	1148	972	253	349	695
2375 x 2250	M 7974	1172	1013	267	368	736
2438 x 2000	I 8066	1142	<b>919</b>	244	335	672
2438 x 2125	I 8070	<b>1184</b>	<b>950</b>	260	357	713
2438 x 2250	I 8074	1193	999	274	379	754
2438 x 2375	I 8079	1284	1145	291	400	798
2438 x 2500	I 8082	1278	1143	304	420	839
2500 x 1875	M 8262	1145	969	235	324	645
2500 x 2000	M 8266	1148	971	251	346	689
2500 x 2125	M 8270	1148	972	266	365	731
2500 x 2250	M 8274	1172	1013	282	388	775
2500 x 2375	M 8279	1236	1142	297	409	816
2500 x 2500	M 8282	1236	1142	313	432	861
2500 x 2750	M 8290	1499	1280	345	473	947
2591 x 2000	I 8666	1142	919	260	357	714
2591 x 2125	I 8670	<b>1184</b>	950	277	380	758
2625 x 2125	M 8770	1296	1104	280	385	768
2740 x 2000	I 9066	1233	1034	274	379	754
2740 x 2125	I 9070	1274	1064	292	402	802
2750 x 2000	M 9166	1316	1102	277	380	757
2750 x 2125	M 9170	1355	1131	293	403	805
2750 x 2250	M 9174	1363	1181	309	426	850
2750 x 2375	M 9179	1399	1229	327	450	899
2750 x 2500	M 9182	1462	1274	345	473	947
2896 x 2000	I 9666	1289	1069	291	400	798
2896 x 2125	I 9670	1338	1107	308	424	846
3000 x 2000	M 91066	1472	1230	300	414	827
3000 x 2125	M 91070	1470	1228	320	439	877
3000 x 2250	M 91074	1485	1292	338	466	929
3000 x 2375	M 91079	1525	1316	357	492	981
3000 x 2500	M 91082	1586	1385	376	517	1032
3000 x 3000	M 910910	1924	1837	450	620	1238
3048 x 2000	I 1066	1245	<b>1069</b>	304	420	839
3048 x 2125	I 1070	<b>1288</b>	<b>1107</b>	324	446	891
3250 x 2000	M 10866	1483	1348	326	448	895
3250 x 2125	M 10870	1521	1375	347	475	950
3250 x 2250	M 10874	1556	1409	365	503	1007
3353 x 2000	I 1166	1466	1489	335	463	923
3353 x 2125	I 1170	1521	1542	357	492	981





Woodgrain

Linear small design

Brickwork opening Width x Height (mm x mm)	Size Code				Surcharge for Standard Colours	Surcharge for Non-Std. Colours	Surcharge for Special RAL
3500 x 2000	<b>M</b>	11666	1579	1458	351	482	963
3500 x 2125	<b>M</b>	11670	1617	1485	373	511	1022
3500 x 2250	<b>M</b>	11674	1655	1516	393	542	1084
3658 x 2000	<b>I</b>	1266	1719	1648	365	504	1007
3658 x 2125	<b>I</b>	1270	1781	1715	389	535	1070
3750 x 2000	<b>M</b>	12466	1664	1556	376	517	1032
3750 x 2125	<b>M</b>	12470	1712	1586	400	548	1095
3750 x 2250	<b>M</b>	12474	1748	1618	422	581	1160
3962 x 2000	<b>I</b>	1366	1780	1684	396	545	1090
3962 x 2125	<b>I</b>	1370	1846	1749	421	580	1157
4000 x 2000	<b>M</b>	13266	1753	1657	401	552	1101
4000 x 2125	<b>M</b>	13270	1804	1684	425	586	1170
4000 x 2250	<b>M</b>	13274	1842	1715	450	620	1238
4250 x 2000	<b>M</b>	131166	1849	1735	425	586	1170
4250 x 2125	<b>M</b>	131170	1902	1765	451	622	1242
4250 x 2250	<b>M</b>	131174	1945	1796	477	659	1316
4267 x 2000	<b>I</b>	1466	<b>1845</b>	1825	426	588	1174
4267 x 2125	<b>I</b>	1470	<b>1917</b>	1919	453	624	1246
4420 x 2000	<b>I</b>	14666	1907	1864	442	608	1215
4420 x 2125	<b>I</b>	14670	1980	1964	470	646	1292
4500 x 2000	<b>M</b>	14966	1943	1858	450	620	1238
4500 x 2125	<b>M</b>	14970	2000	1892	477	659	1316
4500 x 2250	<b>M</b>	14974	2040	1924	506	697	1392
4572 x 2000	<b>I</b>	1566	1940	1875	457	630	1258
4572 x 2125	<b>I</b>	1570	2015	1970	486	668	1335
4725 x 2000	<b>I</b>	15666	2024	1931	472	650	1299
4725 x 2125	<b>I</b>	15670	2101	2028	502	692	1381
4750 x 2000	<b>M</b>	15766	2002	1925	475	654	1306
4750 x 2125	<b>M</b>	15770	2058	1952	504	695	1388
4750 x 2250	<b>M</b>	15774	2099	1985	534	736	1469
4877 x 2000	<b>I</b>	1666	2024	1929	488	672	1341
4877 x 2125	<b>I</b>	1670	2101	2028	518	714	1425
5000 x 2000	<b>M</b>	16566	2059	1979	500	689	1376
5000 x 2125	<b>M</b>	16570	2101	2007	531	731	1461
5000 x 2250	<b>M</b>	16574	2145	2037	562	775	1547
5000 x 2375	<b>M</b>	16579	2189	-	593	816	1633
5000 x 2500	<b>M</b>	16582	2233	-	625	861	1719
5500 x 2000	<b>M</b>	18166	2203	-	551	757	1513
5500 x 2125	<b>M</b>	18170	2261	-	585	805	1606
5500 x 2250	<b>M</b>	18174	2319	-	618	850	1701

<sup>1</sup> Only Linear 1 windows available.

Prices in bold are generally a stock item. Non-bold prices require a longer lead-time.

- I** Imperial door sizes.
- M** Metric door sizes. Extended lead time of 4-6 weeks.
-  Supplied as standard with **tension** spring gear. Torsion spring fitting available for Premium doors at £ 80 surcharge.
-  Supplied as standard with **torsion** spring gear. Low headroom fitting available at £ 131 surcharge.

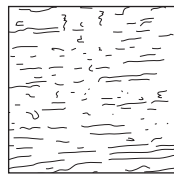
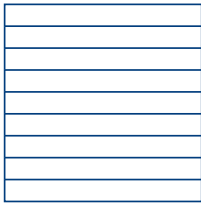

Woodgrain

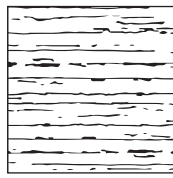

Slategrain<sup>1</sup>

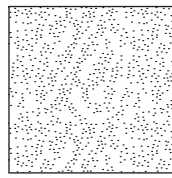

Sandgrain<sup>2</sup>

Linear medium design

Brickwork opening  
Width x Height  
(mm x mm)

Size Code



Premium



Classic<sup>3</sup>



Premium

Traffic White

Anthracite Grey

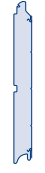

Premium

Traffic White





Anthr. Grey, Terra Brown, White Alum.

Surcharge for Standard Colours

Surcharge for Non-Std. Colours

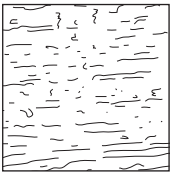
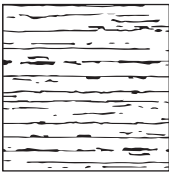
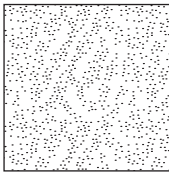
Surcharge for Special RAL

Brickwork opening Width x Height (mm x mm)	Size Code	Premium	Classic <sup>3</sup>	Traffic White	Anthracite Grey	Traffic White	Anthr. Grey, Terra Brown, White Alum.	Surcharge for Standard Colours	Surcharge for Non-Std. Colours	Surcharge for Special RAL
2080 x 1875	I 61062	1004	864	-	-	1067	1262	196	269	537
2080 x 2000	I 61066	1049	-	-	-	1119	1327	209	288	573
2080 x 2080	I 610610	1087	904	-	-	1161	1378	218	298	595
2134 x 2000	I 7066	1086	882	-	-	1119	1332	214	295	588
2134 x 2125	I 7070	1123	903	-	-	1161	1388	227	313	624
2250 x 1875	M 7462	1145	969	1143	1325	1183	1394	212	292	581
2250 x 2000	M 7466	1182	988	1178	1372	1209	1434	226	311	620
2250 x 2125	M 7470	1183	986	1182	1388	1212	1452	239	329	659
2286 x 2000	I 7666	1086	882	-	-	1119	1348	230	316	630
2286 x 2125	I 7670	1123	904	-	-	1161	1404	244	334	668
2286 x 2250	I 7674	1139	952	-	-	1215	1472	258	355	708
2286 x 2375	I 7679	1227	1102	-	-	1268	1540	271	375	747
2286 x 2500	I 7682	1224	1100	-	-	1316	1601	287	393	786
2375 x 1875	M 7962	1145	969	1143	1335	1183	1406	223	307	613
2375 x 2000	M 7966	1148	971	1144	1349	1192	1429	238	328	654
2375 x 2125	M 7970	1148	972	1146	1364	1195	1447	253	349	695
2375 x 2250	M 7974	1172	1013	1168	1398	1241	1508	267	368	736
2438 x 2000	I 8066	1142	919	-	-	1180	1424	244	335	672
2438 x 2125	I 8070	1184	950	-	-	1230	1489	260	357	713
2438 x 2250	I 8074	1193	999	-	-	1268	1542	274	379	754
2438 x 2375	I 8079	1284	1145	-	-	1325	1613	291	400	798
2438 x 2500	I 8082	1278	1143	-	-	1382	1687	304	420	839
2500 x 1875	M 8262	1145	969	1143	1345	1183	1417	235	324	645
2500 x 2000	M 8266	1148	971	1144	1359	1192	1441	251	346	689
2500 x 2125	M 8270	1148	972	1146	1375	1195	1460	266	365	731
2500 x 2250	M 8274	1172	1013	1168	1410	1241	1522	282	388	775
2500 x 2375	M 8279	1236	1142	1233	1489	1317	1612	297	409	816
2500 x 2500	M 8282	1236	1142	1235	1504	1319	1631	313	432	861
2500 x 2750	M 8290	1499	1280	1497	1793	-	-	345	473	947
2591 x 2000	I 8666	1142	919	-	-	1180	1439	260	357	714
2591 x 2125	I 8670	1184	950	-	-	1230	1504	277	380	758
2625 x 2125	M 8770	1296	1104	1294	1534	1354	1633	280	385	768
2740 x 2000	I 9066	1233	1034	-	-	1286	1559	274	379	754
2740 x 2125	I 9070	1274	1064	-	-	1334	1627	292	402	802
2750 x 2000	M 9166	1316	1102	1311	1548	1331	1606	277	380	757
2750 x 2125	M 9170	1355	1131	1353	1605	1384	1674	293	403	805
2750 x 2250	M 9174	1363	1181	1361	1628	1415	1724	309	426	850
2750 x 2375	M 9179	1399	1229	1397	1678	1464	1789	327	450	899
2750 x 2500	M 9182	1462	1274	1459	1755	1527	1870	345	473	947
2896 x 2000	I 9666	1289	1069	-	-	1350	1638	291	400	798
2896 x 2125	I 9670	1338	1107	-	-	1404	1711	308	424	846
3000 x 2000	M 91066	1472	1230	1468	1726	1508	1807	300	414	827
3000 x 2125	M 91070	1470	1228	1469	1744	1508	1826	320	439	877
3000 x 2250	M 91074	1485	1292	1482	1773	1526	1863	338	466	929
3000 x 2375	M 91079	1525	1316	1521	1828	1595	1949	357	492	981
3000 x 2500	M 91082	1586	1385	1583	1906	1661	2035	376	517	1032
3000 x 3000	M 910910	1924	1837	1919	2306	2004	2453	450	620	1238
3048 x 2000	I 1066	1245	1069	-	-	1350	1655	304	420	839
3048 x 2125	I 1070	1288	1107	-	-	1404	1727	324	446	891
3250 x 2000	M 10866	1483	-	1477	1757	1590	1914	326	448	895
3250 x 2125	M 10870	1521	-	1518	1815	1634	1978	347	475	950
3250 x 2250	M 10874	1556	-	1552	1867	1684	2049	365	503	1007
3353 x 2000	I 1166	1466	-	-	-	1599	1934	335	463	923
3353 x 2125	I 1170	1521	-	-	-	1661	2016	357	492	981

											
		Woodgrain			Slategrain <sup>1</sup>		Sandgrain <sup>2</sup>				
Linear medium design											
Brickwork opening Width x Height (mm x mm)	Size Code	Premium	Classic <sup>3</sup>	Premium		Premium		Surcharge for Standard Colours	Surcharge for Non-Std. Colours	Surcharge for Special RAL	
				Traffic White	Anthracite Grey	Traffic White	Anthr. Grey, Terra Brown, White Alum.				
3500 x 2000	<b>M</b>	11666	1579	-	1575	1876	1687	2035	351	482	963
3500 x 2125	<b>M</b>	11670	1617	-	1614	1934	1730	2101	373	511	1022
3500 x 2250	<b>M</b>	11674	1655	-	1650	1989	1783	2177	393	542	1084
3658 x 2000	<b>I</b>	1266	<b>1719</b>	-	-	-	1796	2161	365	504	1007
3658 x 2125	<b>I</b>	1270	<b>1781</b>	-	-	-	1866	2253	389	535	1070
3750 x 2000	<b>M</b>	12466	1664	-	1660	1983	1724	2098	376	517	1032
3750 x 2125	<b>M</b>	12470	1712	-	1710	2053	1777	2175	400	548	1095
3750 x 2250	<b>M</b>	12474	1748	-	1744	2107	1831	2251	422	581	1160
3962 x 2000	<b>I</b>	1366	<b>1780</b>	-	-	-	1848	2243	396	545	1090
3962 x 2125	<b>I</b>	1370	<b>1846</b>	-	-	-	<b>1914</b>	2334	421	580	1157
4000 x 2000	<b>M</b>	13266	1753	-	1748	2092	1808	2207	401	552	1101
4000 x 2125	<b>M</b>	13270	1804	-	1801	2167	1852	2277	425	586	1170
4000 x 2250	<b>M</b>	13274	1842	-	1839	2226	1916	2365	450	620	1238
4250 x 2000	<b>M</b>	131166	1849	-	1845	2211	1881	2306	425	586	1170
4250 x 2125	<b>M</b>	131170	1902	-	1900	2289	1939	2390	451	622	1242
4250 x 2250	<b>M</b>	131174	1945	-	1941	2353	1996	2474	477	659	1316
4267 x 2000	<b>I</b>	1466	<b>1845</b>	-	-	-	<b>1900</b>	2326	426	588	1174
4267 x 2125	<b>I</b>	1470	<b>1917</b>	-	-	-	<b>1975</b>	2428	453	624	1246
4420 x 2000	<b>I</b>	14666	<b>1907</b>	-	-	-	1946	2388	442	608	1215
4420 x 2125	<b>I</b>	14670	<b>1980</b>	-	-	-	<b>2025</b>	2493	470	646	1292
4500 x 2000	<b>M</b>	14966	1943	-	1938	2325	1973	2422	450	620	1238
4500 x 2125	<b>M</b>	14970	2000	-	1996	2408	2035	2513	477	659	1316
4500 x 2250	<b>M</b>	14974	2040	-	2036	2472	2082	2587	506	697	1392
4572 x 2000	<b>I</b>	1566	<b>1940</b>	-	-	-	1963	2419	457	630	1258
4572 x 2125	<b>I</b>	1570	<b>2015</b>	-	-	-	2043	2527	486	668	1335
4725 x 2000	<b>I</b>	15666	<b>2024</b>	-	-	-	1997	2467	472	650	1299
4725 x 2125	<b>I</b>	15670	<b>2101</b>	-	-	-	2076	2575	502	692	1381
4750 x 2000	<b>M</b>	15766	2002	-	1997	2406	2013	2487	475	654	1306
4750 x 2125	<b>M</b>	15770	2058	-	2055	2490	2078	2581	504	695	1388
4750 x 2250	<b>M</b>	15774	2099	-	2095	2555	2139	2670	534	736	1469
4877 x 2000	<b>I</b>	1666	<b>2024</b>	-	-	-	2033	2519	488	672	1341
4877 x 2125	<b>I</b>	1670	<b>2101</b>	-	-	-	2112	2629	518	714	1425
5000 x 2000	<b>M</b>	16566	2059	-	2054	2484	2089	2588	500	689	1376
5000 x 2125	<b>M</b>	16570	2101	-	2098	2555	2143	2673	531	731	1461
5000 x 2250	<b>M</b>	16574	2145	-	2140	2624	2201	2762	562	775	1547
5000 x 2375	<b>M</b>	16579	2189	-	2184	2695	2257	2849	593	816	1633
5000 x 2500	<b>M</b>	16582	2233	-	2228	2766	2310	2934	625	861	1719
5500 x 2000	<b>M</b>	18166	2203	-	2196	2669	2248	2796	551	757	1513
5500 x 2125	<b>M</b>	18170	2261	-	2257	2760	2308	2890	585	805	1606
5500 x 2250	<b>M</b>	18174	2319	-	2314	2847	2369	2987	618	850	1701



<sup>1</sup> Slategrain surface texture only available in Anthracite Grey (RAL 7016) and Traffic White (RAL 9016).

<sup>2</sup> Sandgrain surface available in Traffic White (RAL 9016), Terra Brown (RAL 8028), Anthracite Grey (RAL 7016) and White Aluminium (RAL 9006).

<sup>3</sup> Only Linear 1 windows available.

Prices in bold are generally a stock item. Non-bold prices require a longer lead-time.

- I** Imperial door sizes.
- M** Metric door sizes. Extended lead time of 4-6 weeks.

-  Supplied as standard with tension spring gear. Torsion spring fitting available for Premium doors at £ 80 surcharge.
-  Supplied as standard with torsion spring gear. Low headroom fitting available at £ 131 surcharge.

Purpose-made sizes available upon request. Non standard colours also available upon request. Doors supplied without locking as standard (see options on page 60 for handles). For window options please see page 49.



Linear medium design

Brickwork opening  
Width x Height  
(mm x mm)

Size Code

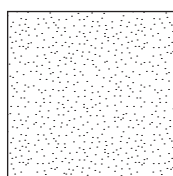

Silkgrain <sup>1</sup>

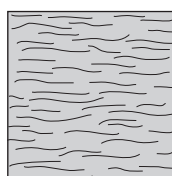

Timber Effect / Titan (CH 703)



Premium



Premium



Surcharge for Standard Colours

Surcharge for Non-Std. Colours

Surcharge for Special RAL

Brickwork opening Width x Height (mm x mm)	Size Code			Surcharge for Standard Colours	Surcharge for Non-Std. Colours	Surcharge for Special RAL	
2080 x 1875	I	61062	1225	1346	196	269	537
2080 x 2000	I	61066	1286	1411	209	288	573
2080 x 2080	I	610610	<b>1332</b>	1464	218	298	595
2134 x 2000	I	7066	<b>1286</b>	<b>1411</b>	214	295	588
2134 x 2125	I	7070	<b>1332</b>	<b>1464</b>	227	313	624
2250 x 1875	M	7462	1366	1508	212	292	581
2250 x 2000	M	7466	1394	1538	226	311	620
2250 x 2125	M	7470	1396	1538	239	329	659
2286 x 2000	I	7666	1286	<b>1411</b>	230	316	630
2286 x 2125	I	7670	<b>1332</b>	<b>1464</b>	244	334	668
2286 x 2250	I	7674	<b>1397</b>	1534	258	355	708
2286 x 2375	I	7679	1457	1602	271	375	747
2286 x 2500	I	7682	1514	1664	287	393	786
2375 x 1875	M	7962	1366	1508	223	307	613
2375 x 2000	M	7966	1375	1515	238	328	654
2375 x 2125	M	7970	1373	1512	253	349	695
2375 x 2250	M	7974	1427	1572	267	368	736
2438 x 2000	I	8066	<b>1358</b>	<b>1495</b>	244	335	672
2438 x 2125	I	8070	<b>1416</b>	<b>1558</b>	260	357	713
2438 x 2250	I	8074	<b>1458</b>	1603	274	379	754
2438 x 2375	I	8079	<b>1526</b>	1680	291	400	798
2438 x 2500	I	8082	1595	1756	304	420	839
2500 x 1875	M	8262	1366	1508	235	324	645
2500 x 2000	M	8266	1375	<b>1515</b>	251	346	689
2500 x 2125	M	8270	1373	1512	266	365	731
2500 x 2250	M	8274	1427	1572	282	388	775
2500 x 2375	M	8279	1517	1672	297	409	816
2500 x 2500	M	8282	1517	1670	313	432	861
2500 x 2750	M	8290	-	-	345	473	947
2591 x 2000	I	8666	1358	1495	260	357	714
2591 x 2125	I	8670	<b>1416</b>	<b>1558</b>	277	380	758
2625 x 2125	M	8770	1568	1733	280	385	768
2740 x 2000	I	9066	1487	1639	274	379	754
2740 x 2125	I	9070	<b>1544</b>	<b>1703</b>	292	402	802
2750 x 2000	M	9166	1543	1706	277	380	757
2750 x 2125	M	9170	1603	1773	293	403	805
2750 x 2250	M	9174	1639	1813	309	426	850
2750 x 2375	M	9179	1694	1872	327	450	899
2750 x 2500	M	9182	1769	1956	345	473	947
2896 x 2000	I	9666	1566	1728	291	400	798
2896 x 2125	I	9670	1627	1796	308	424	846
3000 x 2000	M	91066	1756	1948	300	414	827
3000 x 2125	M	91070	1755	1945	320	439	877
3000 x 2250	M	91074	1774	1967	338	466	929
3000 x 2375	M	91079	1853	2055	357	492	981
3000 x 2500	M	91082	1935	2145	376	517	1032
3000 x 3000	M	910910	2340	2599	450	620	1238
3048 x 2000	I	1066	1566	1728	304	420	839
3048 x 2125	I	1070	<b>1627</b>	1796	324	446	891
3250 x 2000	M	10866	1857	2063	326	448	895
3250 x 2125	M	10870	1908	2119	347	475	950
3250 x 2250	M	10874	1964	2180	365	503	1007
3353 x 2000	I	1166	1867	2069	335	463	923
3353 x 2125	I	1170	<b>1939</b>	2150	357	492	981

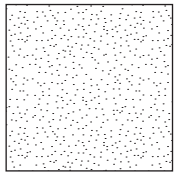
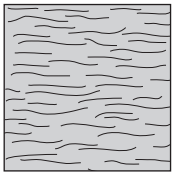



Linear medium design								
			Silkgrain <sup>1</sup>	Timber Effect / Titan (CH 703)				
Brickwork opening Width x Height (mm x mm)	Size Code		Premium		Premium	Surcharge for Standard Colours	Surcharge for Non-Std. Colours	Surcharge for Special RAL
3500 x 2125	<b>M</b>	11670	2025	2252	373	511	1022	
3500 x 2250	<b>M</b>	11674	2085	2319	393	542	1084	
3658 x 2000	<b>I</b>	1266	2105	2339	365	504	1007	
3658 x 2125	<b>I</b>	1270	2184	2429	389	535	1070	
3750 x 2000	<b>M</b>	12466	2019	2246	376	517	1032	
3750 x 2125	<b>M</b>	12470	2082	2317	400	548	1095	
3750 x 2250	<b>M</b>	12474	2145	2386	422	581	1160	
3962 x 2000	<b>I</b>	1366	2168	2410	396	545	1090	
3962 x 2125	<b>I</b>	1370	<b>2247</b>	2499	421	580	1157	
4000 x 2000	<b>M</b>	13266	2121	2363	401	552	1101	
4000 x 2125	<b>M</b>	13270	2173	2421	425	586	1170	
4000 x 2250	<b>M</b>	13274	2247	2503	450	620	1238	
4250 x 2000	<b>M</b>	131166	2210	2463	425	586	1170	
4250 x 2125	<b>M</b>	131170	2277	2538	451	622	1242	
4250 x 2250	<b>M</b>	131174	2344	2613	477	659	1316	
4267 x 2000	<b>I</b>	1466	<b>2231</b>	<b>2483</b>	426	588	1174	
4267 x 2125	<b>I</b>	1470	<b>2319</b>	<b>2581</b>	453	624	1246	
4420 x 2000	<b>I</b>	14666	2288	2547	442	608	1215	
4420 x 2125	<b>I</b>	14670	<b>2378</b>	<b>2648</b>	470	646	1292	
4500 x 2000	<b>M</b>	14966	2322	2592	450	620	1238	
4500 x 2125	<b>M</b>	14970	2393	2670	477	659	1316	
4500 x 2250	<b>M</b>	14974	2448	2730	506	697	1392	
4572 x 2000	<b>I</b>	1566	2305	2566	457	630	1258	
4572 x 2125	<b>I</b>	1570	2400	2674	486	668	1335	
4725 x 2000	<b>I</b>	15666	2350	2617	472	650	1299	
4725 x 2125	<b>I</b>	15670	2440	2719	502	692	1381	
4750 x 2000	<b>M</b>	15766	2369	2646	475	654	1306	
4750 x 2125	<b>M</b>	15770	2446	2730	504	695	1388	
4750 x 2250	<b>M</b>	15774	2517	2809	534	736	1469	
4877 x 2000	<b>I</b>	1666	2390	2662	488	672	1341	
4877 x 2125	<b>I</b>	1670	2484	<b>2767</b>	518	714	1425	
5000 x 2000	<b>M</b>	16566	2461	2750	500	689	1376	
5000 x 2125	<b>M</b>	16570	2525	2822	531	731	1461	
5000 x 2250	<b>M</b>	16574	2593	2894	562	775	1547	
5000 x 2375	<b>M</b>	16579	2659	2968	593	816	1633	
5000 x 2500	<b>M</b>	16582	2722	3039	625	861	1719	
5500 x 2000	<b>M</b>	18166	2655	2969	551	757	1513	
5500 x 2125	<b>M</b>	18170	2725	3046	585	805	1606	
5500 x 2250	<b>M</b>	18174	2796	3127	618	850	1701	

<sup>1</sup> Silkgrain surface supplied with tension spring gear up to 3048 mm wide.

Prices in bold are generally a stock item. Non-bold prices require a longer lead-time.

- I** Imperial door sizes.
- M** Metric door sizes. Extended lead time of 4-6 weeks.

-  Supplied as standard with **tension** spring gear. Torsion spring fitting available for Premium doors at £ 80 surcharge.
-  Supplied as standard with **torsion** spring gear. Low headroom fitting available at £ 131 surcharge.



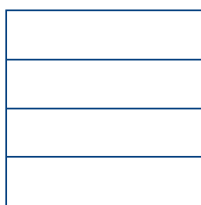

Purpose-made sizes available upon request. Non standard colours also available upon request. Doors supplied without locking as standard (see options on page 60 for handles). For window options please see page 49.

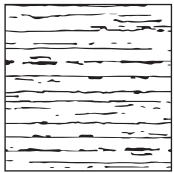
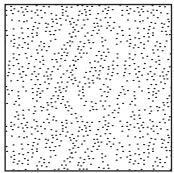
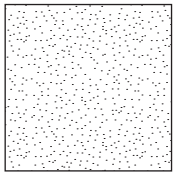
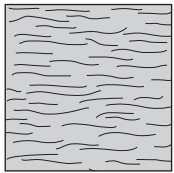

Linear large design

Brickwork opening  
Width x Height  
(mm x mm)

Size Code

											
		Slategrain <sup>1</sup>		Sandgrain <sup>2</sup>		Silkgrain <sup>3</sup>		Timber Effect / Titan (CH 703)			
											
		Premium		Premium		Premium		Premium			
		Traffic White		Anthracite Grey		Traffic White		Anthr. Grey, Terra Brown, White Alum.		Surcharge for Standard Colours	
		-		-		-		-		Surcharge for Non-Std. Colours	
		-		-		-		-		Surcharge for Special RAL	
2080 x 1875	I	61062	-	-	1263	1458	1398	1531	196	269	537
2080 x 2000	I	61066	-	-	1298	1507	1437	1572	209	288	573
2080 x 2080	I	610610	-	-	1316	1531	1454	1590	218	298	595
2134 x 2000	I	7066	-	-	<b>1298</b>	1513	<b>1437</b>	1572	214	295	588
2134 x 2125	I	7070	-	-	<b>1316</b>	1542	<b>1454</b>	<b>1590</b>	227	313	624
2250 x 1875	M	7462	1263	1445	1367	1577	1519	1667	212	292	581
2250 x 2000	M	7466	1299	1493	1396	1622	1549	1698	226	311	620
2250 x 2125	M	7470	1301	1507	1398	1637	1550	1699	239	329	659
2286 x 2000	I	7666	-	-	<b>1298</b>	1527	<b>1437</b>	<b>1572</b>	230	316	630
2286 x 2125	I	7670	-	-	<b>1316</b>	1558	<b>1454</b>	<b>1590</b>	244	334	668
2286 x 2250	I	7674	-	-	<b>1370</b>	1628	<b>1518</b>	1661	258	355	708
2286 x 2375	I	7679	-	-	1379	1651	1525	1666	271	375	747
2286 x 2500	I	7682	-	-	1415	1700	1562	1708	287	393	786
2375 x 1875	M	7962	1263	1455	1367	1590	1519	1667	223	307	613
2375 x 2000	M	7966	1262	1467	1377	1612	1526	1672	238	328	654
2375 x 2125	M	7970	1265	1483	1379	1631	1528	1673	253	349	695
2375 x 2250	M	7974	1286	1516	1423	1690	1574	1724	267	368	736
2438 x 2000	I	8066	-	-	<b>1369</b>	1612	<b>1517</b>	<b>1662</b>	244	335	672
2438 x 2125	I	8070	-	-	<b>1394</b>	1654	<b>1544</b>	<b>1692</b>	260	357	713
2438 x 2250	I	8074	-	-	<b>1462</b>	1736	<b>1622</b>	1776	274	379	754
2438 x 2375	I	8079	-	-	1501	1790	1664	1823	291	400	798
2438 x 2500	I	8082	-	-	1542	1846	1709	1871	304	420	839
2500 x 1875	M	8262	1263	1465	1367	1601	1519	1667	235	324	645
2500 x 2000	M	8266	1262	1477	1377	1626	1526	1672	251	346	689
2500 x 2125	M	8270	1265	1494	1379	1643	1528	1673	266	365	731
2500 x 2250	M	8274	1286	1528	1423	1703	1574	1724	282	388	775
2500 x 2375	M	8279	1360	1616	1490	1787	1651	1808	297	409	816
2500 x 2500	M	8282	1361	1630	1491	1804	1652	1808	313	432	861
2500 x 2750	M	8290	-	-	1654	1950	-	-	345	473	947
2591 x 2000	I	8666	-	-	1369	1629	1517	1662	260	357	714
2591 x 2125	I	8670	-	-	<b>1394</b>	1668	<b>1544</b>	<b>1692</b>	277	380	758
2625 x 2125	M	8770	1433	1673	1579	1860	1758	1934	280	385	768
2740 x 2000	I	9066	-	-	1500	1774	<b>1666</b>	1830	274	379	754
2740 x 2125	I	9070	-	-	<b>1520</b>	1811	<b>1689</b>	<b>1853</b>	292	402	802
2750 x 2000	M	9166	1452	1689	1595	1869	1775	1953	277	380	757
2750 x 2125	M	9170	1500	1752	1628	1918	1810	1993	293	403	805
2750 x 2250	M	9174	1505	1772	1713	2022	1906	2097	309	426	850
2750 x 2375	M	9179	1545	1826	1749	2076	1948	2145	327	450	899
2750 x 2500	M	9182	1616	1912	1790	2135	1996	2195	345	473	947
2896 x 2000	I	9666	-	-	1578	1868	1757	1932	291	400	798
2896 x 2125	I	9670	-	-	<b>1602</b>	1909	<b>1782</b>	1959	308	424	846
3000 x 2000	M	91066	1632	1890	1664	1964	1854	2043	300	414	827
3000 x 2125	M	91070	1630	1905	1664	1982	1852	2039	320	439	877
3000 x 2250	M	91074	1644	1935	1728	2065	1927	2121	338	466	929
3000 x 2375	M	91079	1687	1994	1812	2169	2021	2226	357	492	981
3000 x 2500	M	91082	1758	2081	1840	2214	2050	2257	376	517	1032
3000 x 3000	M	910910	2137	2524	2478	2926	2772	3063	450	620	1238
3048 x 2000	I	1066	-	-	1578	1883	1757	1932	304	420	839
3048 x 2125	I	1070	-	-	<b>1602</b>	1926	<b>1782</b>	1959	324	446	891
3250 x 2000	M	10866	1644	1924	1900	2225	2124	2346	326	448	895
3250 x 2125	M	10870	1690	1987	1928	2272	2156	2381	347	475	950
3250 x 2250	M	10874	1726	2041	1969	2334	2201	2428	365	503	1007
3353 x 2000	I	1166	-	-	1867	2202	2085	2299	335	463	923
3353 x 2125	I	1170	-	-	<b>1895</b>	2250	<b>2116</b>	2333	357	492	981

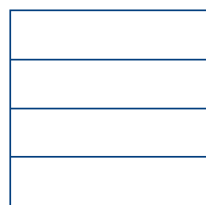

Linear large design			Surface Options				Titan (CH 703)			Surcharge		
			Slategrain <sup>1</sup>	Sandgrain <sup>2</sup>	Silkgrain <sup>3</sup>	Timber Effect / Titan (CH 703)						
Brickwork opening Width x Height (mm x mm)	Size Code	Premium	Premium		Premium		Premium		Premium	Premium	Premium	Premium
			Traffic White	Anthracite Grey	Traffic White	Anthr. Grey, Terra Brown, White Alum.	Traffic White	Anthr. Grey, Terra Brown, White Alum.				
3500 x 2000	<b>M</b>	11666	1754	2055	1942	2291	2174	2401	351	482	963	
3500 x 2125	<b>M</b>	11670	1799	2119	1977	2349	2213	2446	373	511	1022	
3500 x 2250	<b>M</b>	11674	1837	2176	2012	2405	2250	2484	393	542	1084	
3658 x 2000	<b>I</b>	1266	-	-	2102	2467	2355	2603	365	504	1007	
3658 x 2125	<b>I</b>	1270	-	-	<b>2140</b>	2526	<b>2396</b>	2649	389	535	1070	
3750 x 2000	<b>M</b>	12466	1855	2178	1975	2350	2211	2444	376	517	1032	
3750 x 2125	<b>M</b>	12470	1907	2250	1990	2388	2228	2460	400	548	1095	
3750 x 2250	<b>M</b>	12474	1948	2311	2039	2460	2281	2519	422	581	1160	
3962 x 2000	<b>I</b>	1366	-	-	2167	2562	2430	2688	396	545	1090	
3962 x 2125	<b>I</b>	1370	-	-	<b>2199</b>	2618	<b>2462</b>	2723	421	580	1157	
4000 x 2000	<b>M</b>	13266	1954	2298	2121	2520	2378	2631	401	552	1101	
4000 x 2125	<b>M</b>	13270	2013	2379	2176	2600	2439	2697	425	586	1170	
4000 x 2250	<b>M</b>	13274	2054	2441	2228	2676	2497	2763	450	620	1238	
4250 x 2000	<b>M</b>	131166	2063	2429	2244	2668	2519	2790	425	586	1170	
4250 x 2125	<b>M</b>	131170	2125	2514	2288	2738	2568	2843	451	622	1242	
4250 x 2250	<b>M</b>	131174	2170	2582	2332	2809	2618	2898	477	659	1316	
4267 x 2000	<b>I</b>	1466	-	-	<b>2230</b>	2657	<b>2504</b>	<b>2770</b>	426	588	1174	
4267 x 2125	<b>I</b>	1470	-	-	<b>2266</b>	2720	<b>2544</b>	<b>2814</b>	453	624	1246	
4420 x 2000	<b>I</b>	14666	-	-	2292	2733	<b>2572</b>	2847	442	608	1215	
4420 x 2125	<b>I</b>	14670	-	-	<b>2327</b>	2796	<b>2611</b>	<b>2890</b>	470	646	1292	
4500 x 2000	<b>M</b>	14966	2170	2557	2288	2736	2567	2843	450	620	1238	
4500 x 2125	<b>M</b>	14970	2237	2649	2358	2836	2649	2935	477	659	1316	
4500 x 2250	<b>M</b>	14974	2280	2716	2413	2917	2712	3003	506	697	1392	
4572 x 2000	<b>I</b>	1566	-	-	2315	2771	2600	2878	457	630	1258	
4572 x 2125	<b>I</b>	1570	-	-	<b>2352</b>	2837	<b>2640</b>	2923	486	668	1335	
4725 x 2000	<b>I</b>	15666	-	-	2356	2828	2648	2932	472	650	1299	
4725 x 2125	<b>I</b>	15670	-	-	2396	2897	2692	2979	502	692	1381	
4750 x 2000	<b>M</b>	15766	2237	2646	2383	2857	2677	2968	475	654	1306	
4750 x 2125	<b>M</b>	15770	2305	2740	2440	2943	2739	3036	504	695	1388	
4750 x 2250	<b>M</b>	15774	2346	2806	2495	3029	2805	3109	534	736	1469	
4877 x 2000	<b>I</b>	1666	-	-	2398	2884	2694	2982	488	672	1341	
4877 x 2125	<b>I</b>	1670	-	-	<b>2440</b>	2958	<b>2740</b>	<b>3035</b>	518	714	1425	
5000 x 2000	<b>M</b>	16566	2305	2735	2475	2972	2781	3085	500	689	1376	
5000 x 2125	<b>M</b>	16570	2353	2810	2524	3055	2839	3148	531	731	1461	
5000 x 2250	<b>M</b>	16574	2399	2883	2583	3145	2906	3221	562	775	1547	
5000 x 2375	<b>M</b>	16579	2445	2956	2647	3239	2973	3295	593	816	1633	
5000 x 2500	<b>M</b>	16582	2491	3029	2712	3336	3043	3373	625	861	1719	
5500 x 2000	<b>M</b>	18166	2468	2941	2571	3119	2892	3209	551	757	1513	
5500 x 2125	<b>M</b>	18170	2535	3038	2623	3205	2949	3273	585	805	1606	
5500 x 2250	<b>M</b>	18174	2597	3130	2714	3330	3052	3386	618	850	1701	

<sup>1</sup> Slategrain surface texture only available in Anthracite Grey (RAL 7016) and Traffic White (RAL 9016).

<sup>2</sup> Sandgrain surface available in Traffic White (RAL 9016), Terra Brown (RAL 8028), Anthracite Grey (RAL 7016) and White Aluminium (RAL 9006).

<sup>3</sup> Silkgrain surface supplied with tension spring gear up to 3048 mm wide.

Prices in bold are generally a stock item. Non-bold prices require a longer lead-time.

- I** Imperial door sizes.
- M** Metric door sizes. Extended lead time of 4-6 weeks.

- Supplied as standard with **tension** spring gear. Torsion spring fitting available for Premium doors at £ 80 surcharge.
- Supplied as standard with **torsion** spring gear. Low headroom fitting available at £ 131 surcharge.

Purpose-made sizes available upon request. Non standard colours also available upon request. Doors supplied without locking as standard (see options on page 60 for handles). For window options please see page 49.

## Options for sectional doors

add

Special anchor set (required if you fix the door between brickwork and fasten the frame on the side).  
If using special anchor set 90 mm cover profiles will be required to cover fixing holes.

56

Please note: Frame legs for brown and any coloured doors come in white as standard, matching cover profiles are available. Silkgrain, Foil Coated Timber Effect and Titan Metallic (CH 703) are available ex-stock. Please however note Colours and RAL to choose must be ordered with the door and cannot be ordered as a spare part at a later time.

## Cover Profiles

Door height	White				Colour				RAL to choose				Special RAL				Foil Coated Timber Effect / Titan (CH 703)	
	Woodgrain		Slategrain/ Sandgrain/ Silkgrain		Woodgrain		Slategrain/ Sandgrain/ Silkgrain		Woodgrain		Silkgrain		Woodgrain		Silkgrain		55	90
	55	90	55	90	55	90	55	90	55	90	55	90	55	90	55	90	55	90
1875	61	80	68	88	76	108	84	114	105	150	108	162	118	185	122	194	91	124
2000	65	84	72	95	80	114	90	122	110	159	114	173	127	197	131	208	97	131
2125	70	91	76	100	85	124	96	130	117	168	124	185	134	209	139	221	103	139
2250	73	96	80	106	91	130	101	136	125	179	130	194	142	222	147	233	109	148
2375	77	101	84	111	96	136	107	145	131	189	136	205	150	233	155	247	114	156
2500	80	106	88	117	100	143	111	152	137	197	143	216	158	247	163	259	121	163
For door heights not specified above, use formula: door height x price below (i.e. door height 2600 for "White Woodgrain 55": 2.6 x 32.5 = £ 84.5)																		
	32.5	42.4	36.3	46.7	40.2	57.2	44.5	60.4	55.2	79.7	57.2	86.3	62.5	98.4	64.8	103.4	48.4	66.0

## ThermoFrame set

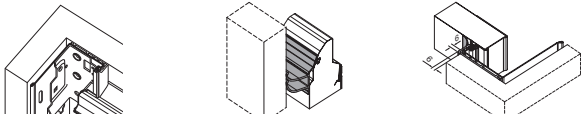
ThermoFrame set 1	Door height	up to 3000 mm	(length 3210 mm)	per set	278
	Door width	up to 3250 mm	(length 3250 mm)		
ThermoFrame set 2	Door height	up to 3000 mm	(length 3210 mm)	per set	329
	Door width	from 3250 mm up to 6000 mm	(length 6000 mm)		
			Set consists of <ul style="list-style-type: none"> <li>• Lintel seal (1x) with 2 lip seals</li> <li>• Plastic angle profiles (2x) black, 84 x 22.5 mm with lip seal (frame covering may be required to match the colours)</li> </ul>		

Purpose-made width cut-down service (check for size limitations). Cut-down service not available on Classic Doors. <sup>1</sup>	116
Purpose-made height cut-down service (check for size limitations). Cut-down service not available on Classic doors. <sup>1</sup>	140
Classic black handle set and lock for on-site installation	65
White finish cast aluminium handle set and lock for on-site installation	179
Silver finish cast aluminium handle set and lock for on-site installation	157
Brown finish cast aluminium handle set and lock for on-site installation	179
Factory cut hole for handle and lock available with a 2 week increase in lead-time (complete with classic black handle as standard) <sup>1</sup>	99
Standard headroom torsion spring for sectional door less than 4000 mm wide <sup>2</sup>	80
Low headroom tracks arrangement for torsion spring door over 4000 mm wide (when purchased with door) <sup>2</sup>	131

<sup>1</sup> Please note: Only available for stock doors (highlighted in bold) on pages 50 - 57. For sectional doors less than 2000 mm wide, an additional charge of £ 475 is applied for the cut-down service.

<sup>2</sup> Excluding Silkgrain. For Silkgrain surface finish, torsion spring gear can be only be supplied on doors over 3050 mm wide.

Sectional doors up to 4000mm wide and/ or 2500mm high (excluding Silkgrain surface finish) and  
 Sectional doors up to 3048mm wide and/ or 2500mm high (with Silkgrain surface finish):

These doors come with tension spring fitting. With doors from the Premium range the tension springs can be replaced by torsion springs as an option. Tension springs are suitable for low headroom installations. For a low headroom installation with torsion springs please order low headroom track set separately (changing to a low headroom option is not available as a retrofit).

 **Sectional garage door with tension spring fitting**

Minimum garage dimensions for manually operated doors

Headroom:	100 mm
Sideroom:	90 mm (each side)
Depth into garage:	garage door height + 510 mm
Clear passage height for manually operated doors:	garage door height – 80 mm

Minimum garage dimensions for doors with GaraMatic operator

Headroom	115 mm
Sideroom:	90 mm (each side)
Depth into garage:	for doors up to 2125 mm high: 3200 mm for doors up to 2500 mm high: 3450 mm for doors up to 3000 mm high: 4125 mm

Clear passage height for doors with GaraMatic operator:	garage door height – 30 mm
---	----------------------------

Minimum ceiling height:	115 mm
Minimum ceiling height (with ThermoFrame):	145 mm

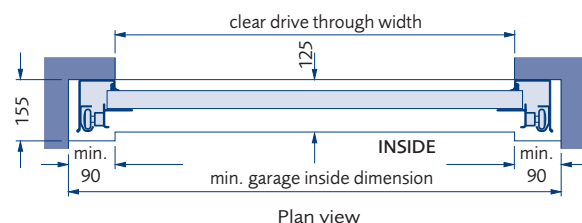
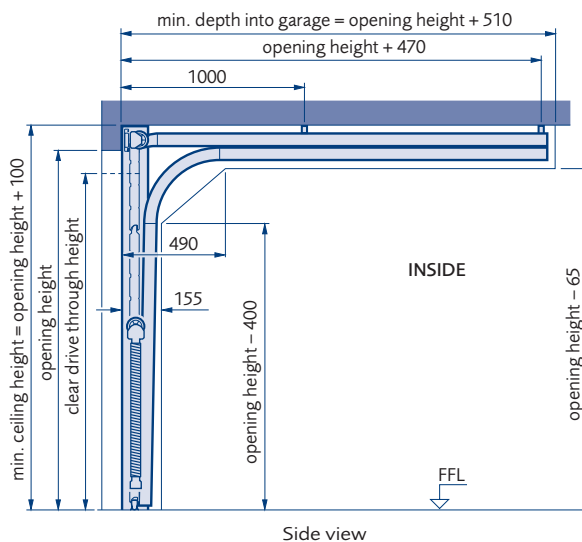

**Sectional doors with torsion spring fitting wider than 4000mm wide (excluding Silkgrain surface finish) and Sectional doors wider than 3048mm wide (with Silkgrain surface finish):**

These doors come with torsion springs as standard. For a low headroom installation with torsion springs please order low headroom track pack (changing to a low headroom option is not available as a retrofit).



**Sectional garage door with torsion spring fitting**

Minimum garage dimensions for manually operated doors

Headroom:	210 mm
Sideroom:	90 mm (each side)
Depth into garage:	garage door height + 510 mm
Clear passage height for manually operated doors:	garage door height – 50 mm

Minimum garage dimensions for doors with GaraMatic operator

Headroom:	210 mm
Sideroom:	90 mm (each side)
Depth into garage:	for doors up to 2125 mm high: 3200 mm for doors up to 2500 mm high: 3450 mm for doors up to 3000 mm high: 4125 mm

Clear passage height for doors with GaraMatic operator: full garage door height

Minimum ceiling height:	210 mm
Minimum ceiling height (with ThermoFrame):	255 mm

Excludes Silkgrain surface finish.  
Torsion spring available for doors over 3000 mm x 2250 mm

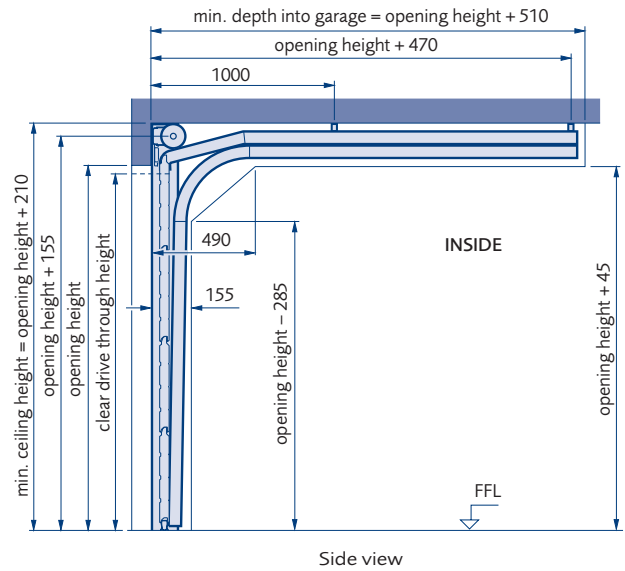

Side view

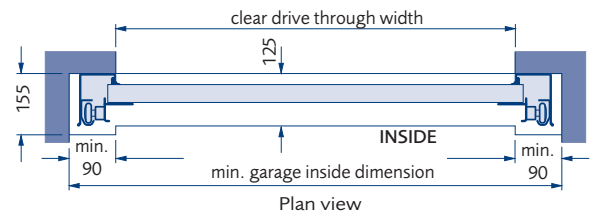

Plan view

Sectional doors with low-headroom torsion spring fitting wider than 4000mm wide (excluding Silkgrain surface finish) and Sectional doors wider than 3048mm wide (with Silkgrain surface finish):

These doors come with torsion springs as standard. For a low headroom installation with torsion springs please order low headroom track pack (changing to a low headroom option is not available as a retrofit).

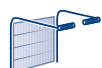
 **Sectional garage door with low headroom torsion spring fitting**

Minimum garage dimensions for manually operated doors

Headroom:	100 mm
Sideroom:	90 mm (each side)
Depth into garage:	garage door height + 510 mm
Clear passage height for manually operated doors:	garage door height – 100 mm

Minimum garage dimensions for doors with GaraMatic operator

Headroom:	115 mm
Sideroom:	90 mm (each side)
Depth into garage:	for doors up to 2125 mm high: 3200 mm for doors up to 3000 mm high: 4125 mm
Clear passage height for doors with GaraMatic operator:	for doors up to 3000 mm wide: garage door height – 30 mm for doors wider than 3000 mm: garage door height – 80 mm

Minimum ceiling height:	115 mm
Minimum ceiling height (with ThermoFrame):	145 mm

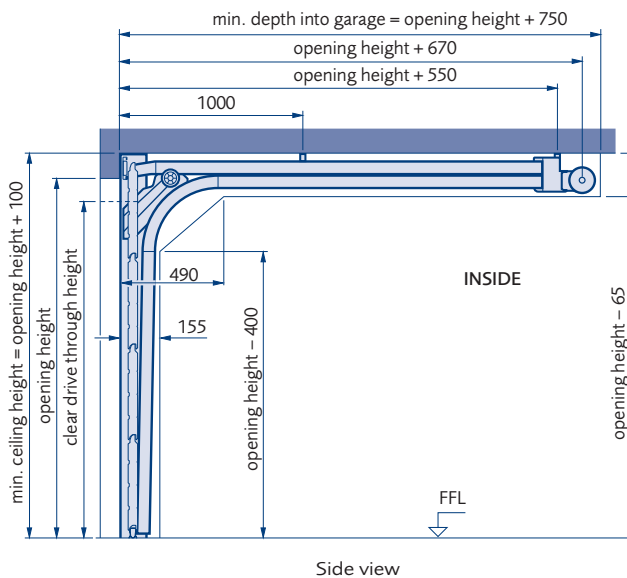

Side view

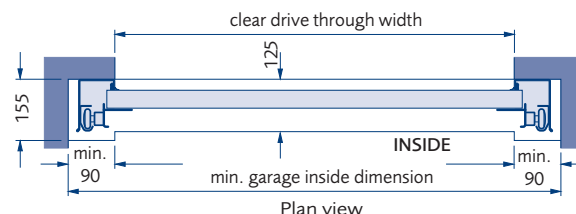

Plan view

# Automation and Accessories

## Operators

GaraMatic operators are an ideal match for all current Garador up & over and sectional garage doors. They are a tried and tested hardware combination, designed for use with Garador up & over or sectional garage doors, and prepared for easy installation. They feature energy efficient LED light, a power saving mode and a mechanical lock, built into the operator boom, to prevent forced lifting of the door.

## What's Included

All GaraMatic operators come as a complete set, including operator head, boom and two 4-button hand transmitters.



### BlueSecur App

The Garador BlueSecur app allows you to control your Series 4 GaraMatic operator from your android or ios smartphone. It allows you to operate the open/close, partial opening and integral light functions.



Both the GaraMatic 10 and GaraMatic 20 are supplied complete with an integrated bluetooth receiver, for control via Garador's BlueSecur smartphone app for android and ios devices. One free user key is included. Others available via in-app purchase. Please refer to Garador BlueSecur for pricing. The bluetooth receiver can be switched on and off. An optional bluetooth receiver is available as an add-on for the GaraMatic 9.



### BS EN 13241 Compliant

The combination of Garador garage doors with GaraMatic operators complies with the latest European safety standards.

## Operators





	GaraMatic 9	GaraMatic 10	GaraMatic 20
			
	<p><b>Peak forces</b> 750 N</p> <ul style="list-style-type: none"> <li>• Simple to operate</li> <li>• Soft start and stop</li> <li>• Max. opening speed 20 cm/s</li> <li>• Automatic safety reversal</li> <li>• Integral LED light with 10 LEDs</li> <li>• Low power consumption (less than 1 w in stand by mode)</li> <li>• Supplied with two 4-button hand transmitters (black end caps)</li> </ul>	<p><b>Peak forces</b> 800 N</p> <ul style="list-style-type: none"> <li>• Control element with 2x 7-segment display</li> <li>• Soft start and stop</li> <li>• Max. opening speed 25 cm/s</li> <li>• Automatic safety reversal</li> <li>• Adjustable integral LED light with 20 LEDs</li> <li>• Partial opening function</li> <li>• Self-closing timer option</li> <li>• Integrated bluetooth receiver</li> <li>• HCP interface to connect smarhome systems</li> <li>• Low power consumption (less than 1 w in stand by mode)</li> <li>• Supplied with two 4-button hand transmitters (chrome end caps)</li> <li>• BlueSecur App: One free user key included. Others available via in-app purchase</li> </ul>	<p><b>Peak forces</b> 1000 N</p> <ul style="list-style-type: none"> <li>• Control element with 2x 7-segment display</li> <li>• Soft start and stop</li> <li>• Max. opening speed 25 cm/s</li> <li>• Automatic safety reversal</li> <li>• Adjustable integral LED light with 30 LEDs</li> <li>• Partial opening function</li> <li>• Self-closing timer option</li> <li>• Integrated bluetooth receiver</li> <li>• HCP interface to connect smarhome systems</li> <li>• Low power consumption (less than 1 w in stand by mode)</li> <li>• Supplied with two 4-button hand transmitters (chrome end caps)</li> <li>• BlueSecur App: One free user key included. Others available via in-app purchase</li> </ul>
Canopy Doors <sup>1</sup>	556	700	746
Standard short boom <sup>2</sup> Retractable and Sectional Doors up to 2125 mm high	441	543	629
Medium boom <sup>2</sup>	461	566	650
Long boom <sup>2</sup>	567	672	759

<sup>1</sup> Canopy door price includes bow arm system. GaraMatic 9 supplied with two 2-channel hand transmitters.





<sup>2</sup> For exact boom requirements see grid on page 69.







Accessories



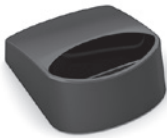

					
Article	Hand transmitter 5-channel (Bi-directional) in matt black	Hand transmitter 4-channel (Bi-directional) in matt black	Hand transmitter 4-channel (Bi-directional) in matt black (chrome caps)	Hand transmitter 5-channel (Bi-directional) in white	Hand transmitter 2-channel (Bi-directional) in white
Reference No.	7471	7470	6809	6713	6711
Price £	83	67	73	91	73

Accessories

				
Article	Hand transmitter 5-channel (Bi-directional) in black	Hand transmitter 2-channel (Bi-directional) in black	Hand transmitter 1-channel (Bi-directional) in black	Hand transmitter 4-channel (Bi-directional) in black
Reference No.	6714	6712	6710	6779
Price £	83	70	67	70





Accessories



				
Article	Hand transmitter station in black	Hand transmitter station in white	Hand transmitter sun visor/ wall holder	1-channel (Bi-directional) transmitter for car cigarette lighter
Reference No.	6719	6720	6784	6782
Price £	16	16	14	63



Accessories				
Article	2-channel (Bi-directional) transmitter for car cigarette lighter	4-channel (Bi-directional) key ring transmitter	Hand transmitter 2-channel (Bi-directional) Burl wood	Hand transmitter 2-channel (Bi-directional) Aluminium
Reference No.	6783	6795	6968	6967
Price £	63	76	89	89

Accessories				
Article	Hand transmitter 2-channel (Bi-directional) Carbon	Hand transmitter 2-channel (Bi-directional) Green	Hand transmitter 2-channel (Bi-directional) Red	Aluminium designer 2-channel transmitter 868 mHz
Reference No.	6966	6965	6964	6780
Price £	89	89	89	94

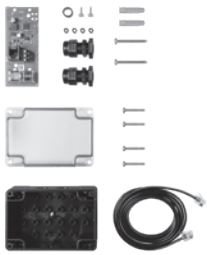
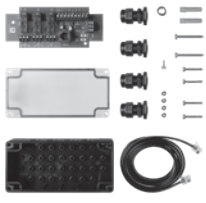
Accessories				
Article	Chrome designer 2-channel transmitter 868 mHz	IT3 B Wired Wall Console	FIT 2 Bi-directional wireless wall console	IT1 B Wired illuminated push button
Reference No.	6781	2873	6718	2875
Price £	94	46	70	33

Accessories				
				
Article	Series 4 External Bluetooth Antenna to increase signal range	IT1-1 Internal Push Button	FCT 3 BS Radio code switch	FCT 10 Wireless Code Switch (slide lid) 868 mHz bi-directional
Reference No.	8128	695	6717	6716
Price £	95.00	30.00	111.00	181.00

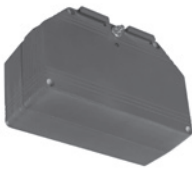
Accessories				
				
Article	Series 4 External Bluetooth receiver (GaraMatic 9 add-on)	Options relay for control of garage light, warning light or limit switch report HOR-HCP	Series 4 Universal Adapter Print for control of operator light, partial open and venti- lation position UAP-1-HCP	EL301N External light beam device
Reference No.	8129	8125	8421	2884
Price £	139.00	59.00	111.00	131

Accessories		
		
Article	Emergency Battery Backup HNA 18-4 (for Series 4 operators)	EL101 Internal light beam device
Reference No.	8126	6786
Price £	221	76

## Additional options

De-latching kit Reference No. 705 for up & over doors, N80 single door range (437.195) (required to maintain mechanical locking system retractable doors only)	53
De-latching kit Reference No. 2643 for up & over doors, N800 double door range (437.197) (required to maintain mechanical locking system retractable doors only)	51
Emergency release Reference No. 704 for retractable up & over doors only (required if door is electrically operated and has no other personal access)	34
Emergency release Reference No. 703 for sectional door without handle and lock, or canopy up & over doors (required if door is electrically operated and has no other personal access)	48
Emergency release Reference No. 702 for sectional door with handle and lock (required if door is electrically operated and has no other personal access)	49
Lintel extension bracket Reference No. 709 for canopy doors (required if door is fitted between brickwork under the lintel)	48

## Operator Specifications

### Boom for canopy door including canopy bow arm

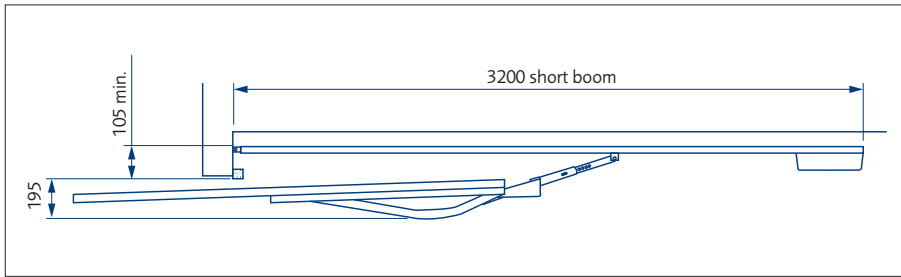

On horizontal doors the bow arm is to be fitted off centre.

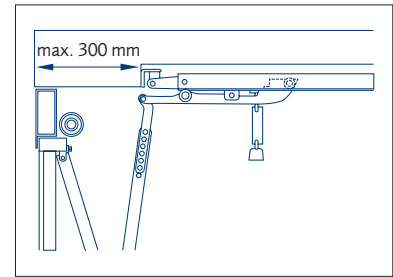

Lintel extension bracket required for canopy doors fitted between the brickwork and under the lintel head.

### Boom for retractable door

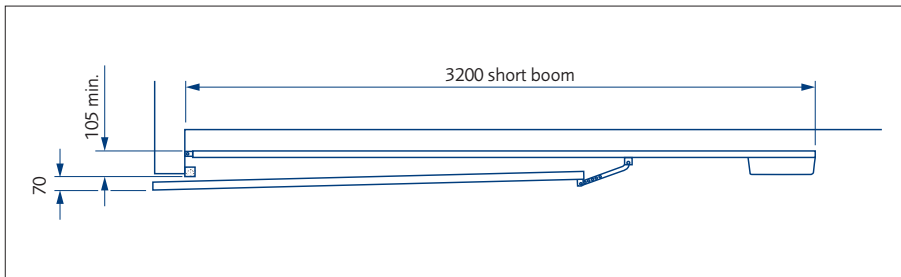

### Boom for sectional door

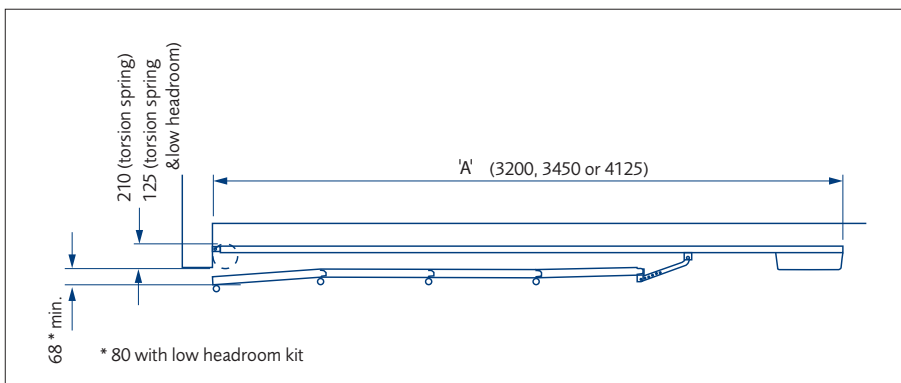

### Maximum Door Height to suit Operator Booms

	Torsion Spring	Tension and Low Headroom Spring	Travel distance
Short Boom	2250 mm	2125 mm	2475 mm
Medium Boom	2500 mm	2375 mm	2725 mm
Long Boom	3000 mm	3000 mm	3400 mm

# GaraRoll Roller Doors

## GaraRoll Insulated Roller Doors

Spring-compensated, automated roller garage door for domestic applications only. All doors are made to suit the opening with the actual door size relating to the structural opening width x height and the guides fitting on the reveals to maintain a full opening size. The GaraRoll is the only roller garage door to include the cover hood, which the curtain rolls into at the head of the garage door opening, as standard.

### Door curtain

77 mm rolled aluminium profile filled with 100% CFC-free polyurethane rigid foam.  
Integrated windlocks fitted as standard.

### Surface

Colour finish with double layer coil coating quality paint system or foil-coated timber effect finish.

### Frame

Aluminium extrusion profile side guides with integrated plastic runners. Lintel and cover box made of steel. Colour of side guides and lintels supplied to match the door as standard. Except on foil-coated and deco paint timber effect doors where they are supplied in a solid brown paint finish. Cover box coated Grey White (RAL 9002).

### Counterbalance

Tension spring technology with lateral integral double tension springs and double cables encased within a transparent cover.

### Colours

Same colour inside and outside

- |                          |                              |                          |   |
|--------------------------|------------------------------|--------------------------|---|
| - Light Ivory (RAL 1015) | - Moss Green (RAL 6005)      | - Terra Brown (RAL 8028) | - White Aluminium (RAL 9006)            |
| - Ruby Red (RAL 3003)    | - Slate Grey (RAL 7015)      | - Cream (RAL 9001)       | - Grey Aluminium (RAL 9007)             |
| - Purple Red (RAL 3004)  | - Anthracite Grey (RAL 7016) | - Jet Black (RAL 9005)   | - Traffic White (RAL 9016)              |
| - Steel Blue (RAL 5011)  | - Light Grey (RAL 7035)      | - Chartwell Green        | - Anthracite Metallic (Noir 2100 Sable) |

Deco paint doors available in Golden Oak and Rosewood with the same finish inside and out.

Foil-coated doors available in Golden Oak and Rosewood, with the inside of the lath in dark brown (foil coat not available on GaraRoll external roller garage door).

### Operator and Control

Garador operator and control included. 24 V DC gear drive, mains voltage 230-240 V AC, 0.5 kW, opening speed approx. 11 cm/s, integrated door security kit, operator always located on left (viewed from inside), plastic housing. Micro-processor control in separate plastic housing, automatic teaching of auto safety cut-out and travel limits, soft start and soft stop, light, impulse control, adjustable automatic timer (hold-open time 30 sec. after activation, additional photocell required).

Included: 2 hand transmitters and integral receiver, connecting lead with CEE plug, control buttons in cover of the control unit, integrated 2-minute garage light in control housing, quick release (operated from inside).

### Windows

Window size approx. 120 x 40 mm, number of windows per door section depends on door width. Windows made of clear synthetic pane with black window frame on exterior, transparent frame on interior. Maximum of 10 window sections per door.

Window arrangement:

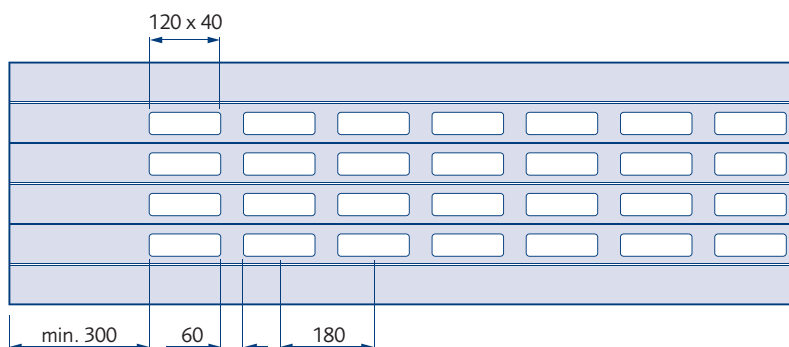

### Packaging

GaraRoll doors are supplied in a palletted format shrink wrapped as a complete package.

**Stock availability**

All GaraRoll doors are made to order with no standard sizes. Lead-time for all doors is 3 to 4 weeks.

**Remember the GaraRoll door is measured as opening size and not as overall guide width.**

This not only makes it the same as all other Garador doors for sizing but also will probably reduce the price against other doors as most other door manufacturers calculate the price as over guide width thus making the actual door around 220 mm smaller!

Minimum product dimension is 1250 mm x 1875 mm.

Only the door prices highlighted are available with the external roller garage door fitting as an option.

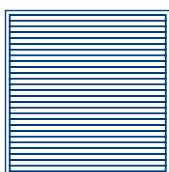

**Smooth paint finish**

		Door width																					
		1000	1250	1500	1750	1900	2000	2250	2500	2750	3000	3250	3500	3750	4000	4250	4500	4750	5000	5250	5500	5750	6000
Door height	1600		1734	1734	1767	1767	1785	1884	1951	2018	2048	2152	2221	2503	2566	2684	2746	2813	2879	2945	3012	3078	3145
	1800		1734	1734	1767	1767	1785	1884	1951	2018	2048	2152	2221	2503	2566	2684	2746	2813	2879	2945	3012	3078	3145
	2000		1734	1734	1767	1767	1851	1971	2003	2059	2117	2230	2306	2612	2638	2802	2868	2934	3000	3066	3131	3196	3261
	2125		1734	1734	1767	1767	1883	2030	2082	2126	2207	2348	2598	2702	2728	2882	2947	3014	3078	3141	3206	3270	3334
	2250		1734	1734	1767	1767	1883	2030	2082	2126	2207	2348	2598	2702	2728	2882	2947	3014	3078	3141	3206	3270	3334
	2375		1853	1853	1924	1924	1949	2065	2136	2216	2279	2428	2699	2754	2865	2984	3050	3116	3180	3244	3307	3372	3435
	2500		1853	1853	1924	1924	2016	2127	2199	2281	2368	2690	2805	2907	3008	3086	3153	3217	3280	-	-	-	-
	2625		1853	1853	1924	1924	2016	2127	2199	2281	2368	2690	2805	2907	3008	3086	3153	3217	3280	-	-	-	-
	2675		-	-	-	-	2016	2127	2199	2281	2368	2690	2805	2907	3008	-	-	-	-	-	-	-	-
	2750		-	-	-	-	2044	2221	2279	2352	2412	2771	2870	2991	3052	-	-	-	-	-	-	-	-
	2875		-	-	-	-	2044	2221	2279	2352	2412	2771	2870	2991	3052	-	-	-	-	-	-	-	-
	3000		-	-	-	-	2044	2221	2279	2352	2412	2771	2870	2991	3052	-	-	-	-	-	-	-	-
	3100		-	-	-	-	2044	2221	2279	2352	2412	2771	2870	2991	3052	-	-	-	-	-	-	-	-

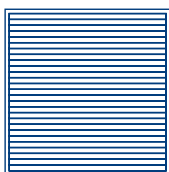

**Deco paint finish**

		Door width																					
		1000	1250	1500	1750	1900	2000	2250	2500	2750	3000	3250	3500	3750	4000	4250	4500	4750	5000	5250	5500	5750	6000
Door height	1600		1811	1811	1857	1864	1886	2000	2077	2155	2201	2318	2398	2693	2768	2898	2973	3053	3132	3186	3267	3344	3423
	1800		1811	1811	1857	1864	1886	2000	2077	2155	2201	2318	2398	2693	2768	2898	2973	3053	3132	3212	3292	3372	3452
	2000		1815	1815	1863	1871	1959	2092	2141	2209	2278	2407	2495	2815	2853	3031	3111	3188	3270	3348	3429	3508	3588
	2125		1821	1821	1869	1877	1999	2158	2225	2286	2380	2534	2798	2915	2955	3124	3205	3284	3364	3444	3521	3600	3680
	2250		1825	1825	1875	1882	2004	2167	2233	2293	2388	2544	2810	2929	2968	3139	3217	3302	3378	3456	3535	3613	3691
	2375		1949	1949	2034	2044	2076	2208	2294	2390	2469	2635	2922	2991	3117	3254	3335	3417	3496	3575	3653	3733	3811
	2500		1954	1954	2040	2049	2149	2277	2364	2464	2569	2906	3036	3156	3275	3369	3450	3530	3611	-	-	-	-
	2625		1956	1956	2043	2051	2151	2281	2366	2469	2573	2910	3042	3161	3279	3374	3455	3538	3616	-	-	-	-
	2675		-	-	-	-	2153	2287	2371	2474	2579	2916	3050	3170	3286	-	-	-	-	-	-	-	-
	2750		-	-	-	-	2189	2387	2461	2552	2631	3008	3124	3264	3343	-	-	-	-	-	-	-	-
	2875		-	-	-	-	2196	2393	2469	2563	2638	3019	3136	3276	3356	-	-	-	-	-	-	-	-
	3000		-	-	-	-	2202	2398	2477	2568	2647	3028	3145	3285	3367	-	-	-	-	-	-	-	-
	3100		-	-	-	-	2202	2398	2477	2568	2647	3028	3145	3285	3367	-	-	-	-	-	-	-	-

Deco paint only available in Golden Oak, Anthracite Metallic (Noir 2100 Sable) or Rosewood finish.

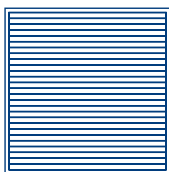

## Timber effect finish

Door height	Door width																						
	1000	1250	1500	1750	1900	2000	2250	2500	2750	3000	3250	3500	3750	4000	4250	4500	4750	5000	5250	5500	5750	6000	
1600																							
1800	2106	2106	2174	2195	2226	2368	2472	2580	2646	2793	2903	3245	3346	3508	3611	3716	3821	3858	3959	4062	4163		
2000	2106	2106	2174	2195	2226	2368	2472	2580	2646	2793	2903	3245	3346	3508	3611	3716	3821	3925	4030	4134	4239		
2125	2118	2118	2187	2209	2317	2482	2552	2650	2748	2907	3025	3395	3459	3673	3783	3888	3995	4103	4210	4315	4424		
2250	2131	2131	2204	2225	2367	2566	2660	2746	2871	3063	3374	3524	3591	3798	3906	4015	4124	4231	4338	4445	4553		
2375	2143	2143	2217	2241	2385	2584	2681	2769	2893	3089	3404	3554	3622	3832	3941	4056	4165	4274	4382	4492	4602		
2500	2287	2287	2402	2427	2471	2639	2758	2888	3000	3205	3544	3644	3804	3979	4092	4207	4317	4427	4538	4649	4760		
2625	2297	2297	2416	2442	2562	2728	2847	2983	3122	3519	3690	3844	3998	4125	4242	4354	4467	-	-	-	-		
2675	2302	2302	2420	2449	2568	2735	2856	2994	3132	3529	3700	3857	4010	4136	4254	4368	4480	-	-	-	-		
2750	-	-	-	-	2577	2748	2869	3005	3147	3547	3718	3873	4030	-	-	-	-	-	-	-	-		
2875	-	-	-	-	2625	2868	2980	3106	3217	3662	3816	3995	4110	-	-	-	-	-	-	-	-		
3000	-	-	-	-	2638	2887	3000	3127	3243	3689	3844	4028	4144	-	-	-	-	-	-	-	-		
3100	-	-	-	-	2654	2902	3015	3147	3261	3707	3867	4051	4168	-	-	-	-	-	-	-	-		

Timber Effect Foil Coat only available in Golden Oak and Rosewood finish.

### Options for GaraRoll doors add

Surcharge for different colour frame and guides to door colour 113

Manually operated version (not possible on external fit) Price reduction 180

Removal of barrel casing (optional only on door height 2500 mm and over) Price reduction per m 17

External fit (reverse rolled) 81

Chamfered bottom profile available only in White or Colour.  
Not available in timber effect finish per m 237

Ventilation grilles or Glazing element with clear synthetic pane, window section  
120 x 40 mm, black glazing frame on exterior, transparent on interior (maximum of  
10 sections per door, number of glazing elements dependent on the door width)<sup>1</sup> per m 28

<sup>1</sup> Not available in top 6 laths.

### Accessories for GaraRoll operator add

Bi-directional hand transmitter, 5-channel in black 88

Bi-directional hand transmitter mini, 4-channel in black 73

Motor connection line, 10 m - Reference No. 5498 41

Acoustic door security kit - Reference No. 5499 70

Emergency battery HNA 18 - Reference No. 5500 226

Exterior emergency release - Reference No. 5501 107

Additional fascia panel required when fitting a door within the opening, ordering size will need to be door size  
plus guide width (price per metre) supplied in colour to match the door / guides 59

All other operator accessories can be combined with GaraRoll roller doors. Please see page 65 to page 68.



## Roller door fitting dimensions

### Fitting behind the opening

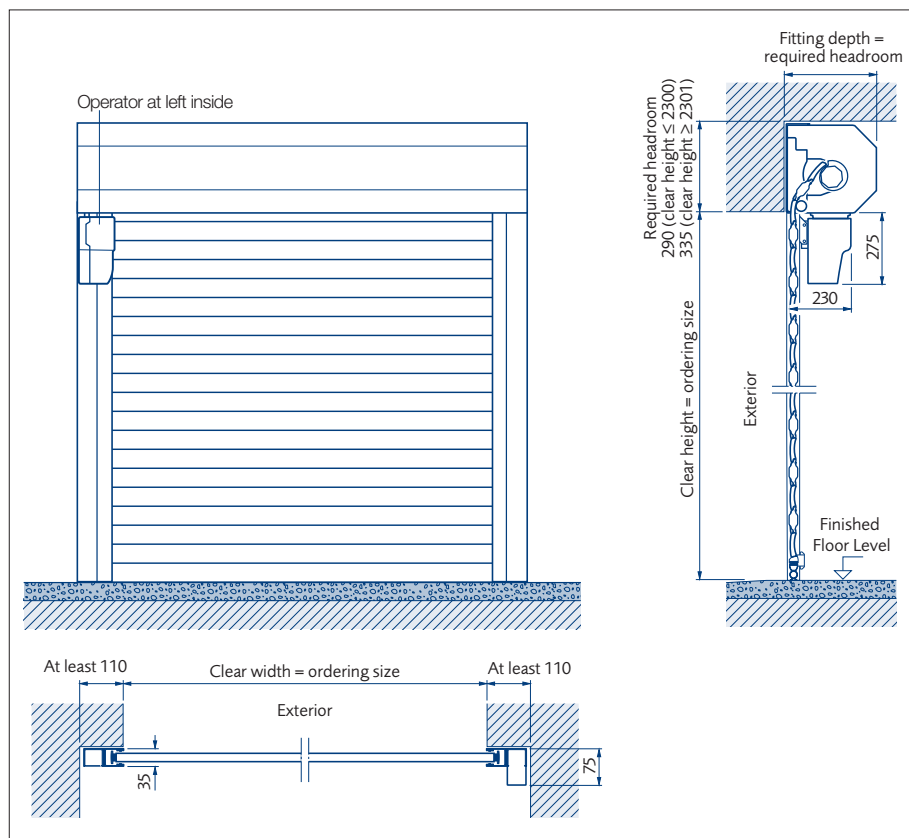

Clear passage width =  
clear width (ordering size)

Clear passage height =  
clear height (ordering size)  
– 60 mm for automated version,  
– 140 mm for manually operated version

### Fitting in the opening

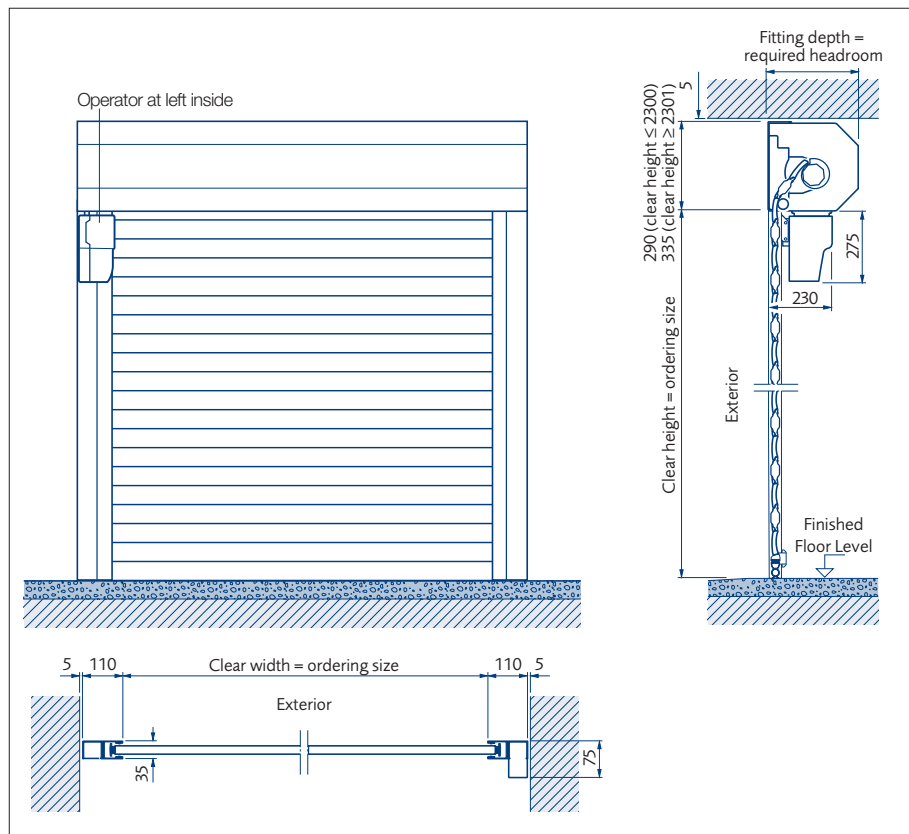

Clear passage width =  
clear width (ordering size)

Clear passage height =  
clear height (ordering size)  
– 60 mm for automated version,  
– 140 mm for manually operated version

# GaraGlide Roller Doors

A motor driven, roller garage door with tubular drive motor, closing edge safety device and manual hand crank for emergencies. The emergency release kit is not available for a retro-fit application so must be ordered with the original door. All doors are built to suit the opening, with the actual door size relating to the structural opening width x height and the guides fitting on the reveals to maintain a full opening size. Please refer to sizing tables for full range of size options.

## Door Curtain

77 mm rolled aluminium profile with 100 % CFC-free polyurethane rigid foam. Available in 16 standard colour, with a two-layer paint finish using a high-quality polyurethane paint coated with a polyimide.

## Frame and Construction

75mm guide rails for single doors and 105 mm for double doors. Guide rails are supplied in a colour to match the door curtain and with an integrated brush strip either side. The box cover, rollers and barrel are pre-assembled for convenience. Please state on your order if fitting between or behind opening.

## Operator and Control

GaraGlide operator and control included. 24 V DC gear drive, mains voltage 230 - 240 V AC, 0.5 KW, anti-lift kit, operator built into tubular drive with control board located on right as standard (viewed from inside) and impulse control. Included: 2 x standard hand transmitters and integral receiver, connecting lead with CEE plug, control buttons in cover of the control unit, integrated 2-minute garage courtesy light in control housing. The motor can be fitted either side. Also features an adjustable reversing procedure, adjustable pre-warning phase, adjustable automatic timer, connection of external illumination is possible and there is also a connecting option for a one-way photo cell.

## Standard Colours

GaraGlide roller doors are available in a choice of 15 standard colours, with the door curtain interior and exterior painted the same colour:

- Traffic White (RAL 9016)   - Steel Blue (RAL 5011)   - Light Grey (RAL 7035)   - White Aluminium (RAL 9006)
- Light Ivory (RAL 1015)   - Moss Green (RAL 6005)   - Terra Brown (RAL 8028)   - Grey Aluminium (RAL 9007)
- Ruby Red (RAL 3003)   - Slate Grey (RAL 7015)   - Cream (RAL 9001)   - Chartwell Green
- Purple Red (RAL 3004)   - Anthracite Grey (RAL 7016)   - Jet Black (RAL 9005)

Anthracite Metallic (Noir 2100 Sable) is also available at an additional cost. See page 75 for additional colour options.

## Timber Effect Colours

A timber effect version is available in Golden Oak or Rosewood effect, where the exterior door curtain is coated in a UV-resistant synthetic foil with a timber effect design and embossed grain, and the interior of the door curtain is painted in Terra Brown (RAL 8028). A Deco Paint version is also available at a lower cost, where the laths are painted in a Golden Oak or Rosewood effect.

## Fitting

The GaraGlide is suitable for fitting between and behind a prepared brickwork opening.

## Packaging

GaraGlide roller doors are supplied in two twin-walled cardboard boxes for ease of transportation to site.

## Stock Availability

All GaraGlide doors are made to order with no standard sizes. Lead-time for all doors is 4 weeks.

## Size range

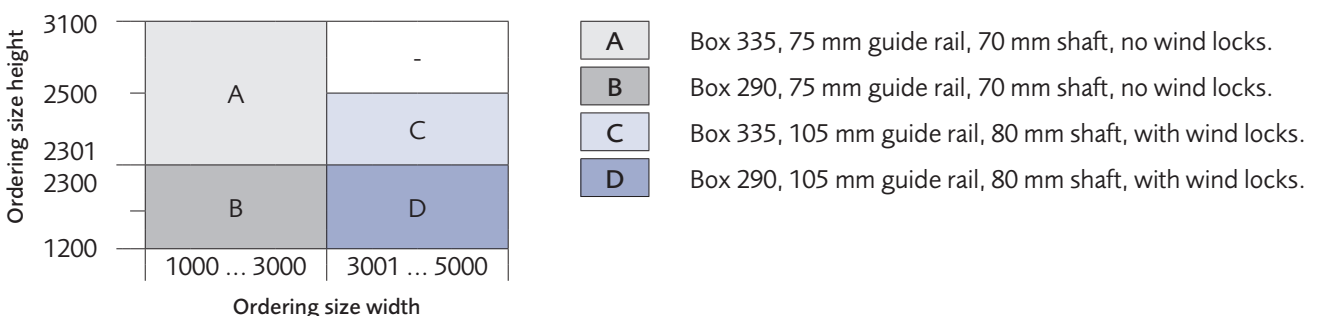

## Options for all GaraGlide roller garage doors

### Emergency Release

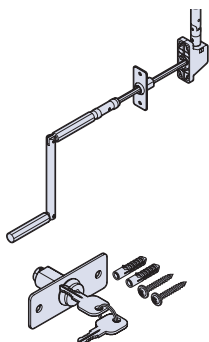

Exterior emergency release kit  
(Please note: the emergency release kit is not available for a retro-fit application so must be ordered with the original door).

each 236

### Ventilation Grilles and Glazing Elements



Glazing element (clear synthetic pane, window cut-out 112 mm x 33 mm)

per m 30



Ventilation grilles (black plastic with ventilation cross section approx 13 cm<sup>2</sup> / grille)

per m 30

### Additional Fascia Panel

Reinforcement of the fascia panel (required for fitting between opening)

per m 71

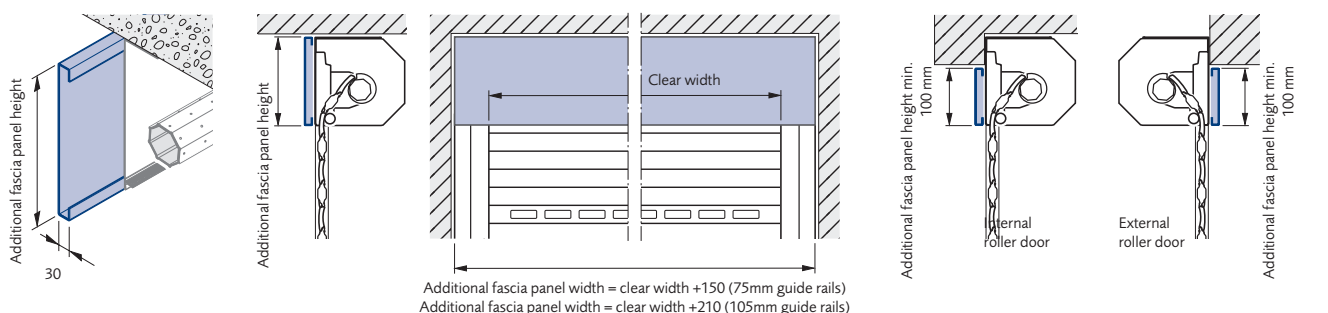

### Additional Colour Options

Standard colours (choice of 15 colour options)	Included	
Anthracite Metallic (Noir 2100 Sable)	per m <sup>2</sup>	28
Deco Paint (painted timber effect design in Golden Oak or Rosewood)	per m <sup>2</sup>	28
Timber effect (plastic film coating in Golden Oak or Rosewood timber effect)	per m <sup>2</sup>	52

Add £48 surcharge for external fit GaraGlide roller door.

Add £122 surcharge, to request the door curtain in one colour and the guide rails/box cover in an alternative colour.

Example of paint cost calculation:

For door dimensions of 2000 mm x 2125 mm, the door area is 4.25 m<sup>2</sup> (i.e. 2 x 2.125 = 4.25).

Multiply door area by cost per m<sup>2</sup> to calculate additional paint cost (i.e. 4.25 x 28 = £119).

Please note, dark colours should not be used for doors that are exposed to the sun. Despite the use of state-of-the-art colour coating systems, we cannot rule out colour deviations, specifically in metallic colours (RAL 9006 and RAL 9007). Please state on your order if fitting between or behind opening.

External fit GaraGlide roller doors are only available up to 5000 mm wide and are not available in a timber effect finish.

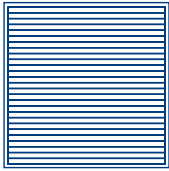

**GaraGlide 1**

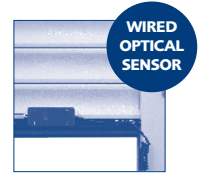

Door width

Door height	1000	1250	1500	1750	2000	2250	2500	2750	3000	3250	3500	3750	4000	4250	4500	4750	5000
1200		1526	1563	1582	1618	1653	1688	1722	1772	2037	2072	2108	2141	2175	2220	2254	2291
1500		1552	1589	1616	1656	1695	1735	1775	1828	2099	2138	2175	2214	2254	2303	2342	2382
1750		1570	1612	1645	1688	1730	1769	1811	1870	2146	2188	2230	2273	2315	2368	2409	2451
2000		1578	1621	1653	1695	1737	1782	1825	1881	2161	2204	2247	2291	2333	2387	2430	2475
2125		1589	1636	1669	1713	1759	1806	1851	1910	2193	2239	2284	2329	2374	2430	2475	2520
2250		1610	1658	1695	1742	1794	1841	1892	1952	2239	2286	2333	2382	2501	2560	2607	2657
2375		1618	1666	1705	1754	1801	1853	1902	1966	2254	2305	2353	2406	2484	2584	2633	2681
2500		1645	1698	1740	1794	1848	1902	1954	2023	2318	2372	2424	2478	-	-	-	-
2750		1669	1730	1775	1830	1892	1947	2006	2079	2451	2506	2565	2623	-	-	-	-
3100																	

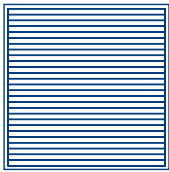

**GaraGlide 2**

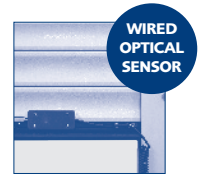

Door width

Door height	1000	1250	1500	1750	2000	2250	2500	2750	3000	3250	3500	3750	4000	4250	4500	4750	5000
1200		1570	1607	1626	1662	1697	1732	1766	1816	2081	2116	2152	2185	2219	2264	2298	2336
1500		1596	1633	1660	1700	1739	1779	1819	1872	2143	2182	2219	2258	2298	2347	2386	2426
1750		1615	1657	1690	1732	1774	1813	1856	1914	2190	2233	2275	2317	2359	2413	2453	2495
2000		1623	1665	1697	1739	1781	1827	1869	1926	2206	2248	2291	2336	2378	2431	2475	2519
2125		1633	1680	1713	1758	1803	1850	1896	1954	2238	2283	2328	2374	2418	2475	2519	2564
2250		1655	1702	1739	1787	1838	1885	1936	1997	2283	2330	2378	2426	2546	2604	2652	2701
2375		1662	1710	1749	1798	1845	1898	1946	2010	2298	2349	2397	2450	2528	2628	2677	2725
2500		1690	1742	1784	1838	1893	1946	1999	2068	2362	2416	2468	2522	-	-	-	-
2750		1713	1774	1819	1874	1936	1991	2050	2123	2495	2551	2609	2667	-	-	-	-
3100																	

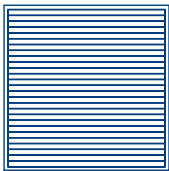

**GaraGlide 3**



Door width

Door height	1000	1250	1500	1750	2000	2250	2500	2750	3000	3250	3500	3750	4000	4250	4500	4750	5000
1200		1699	1736	1755	1791	1826	1861	1895	1945	2210	2245	2281	2314	2348	2393	2427	2464
1500		1725	1762	1789	1829	1868	1908	1948	2001	2272	2311	2348	2387	2427	2476	2515	2555
1750		1743	1785	1818	1861	1903	1942	1984	2043	2319	2361	2403	2446	2488	2542	2582	2624
2000		1751	1794	1826	1868	1910	1955	1998	2054	2334	2377	2420	2464	2506	2560	2603	2648
2125		1762	1809	1842	1886	1932	1979	2024	2083	2366	2412	2457	2502	2547	2603	2648	2693
2250		1783	1831	1868	1915	1967	2014	2065	2125	2412	2459	2506	2555	2674	2733	2780	2830
2375		1791	1839	1878	1927	1974	2027	2075	2139	2427	2478	2526	2579	2657	2757	2806	2854
2500		1818	1871	1913	1967	2021	2075	2127	2196	2491	2545	2597	2651	-	-	-	-
2750		1842	1903	1948	2003	2065	2120	2179	2252	2624	2680	2738	2796	-	-	-	-
3100																	

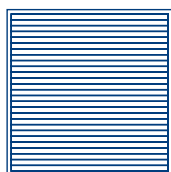

**GaraGlide 4**

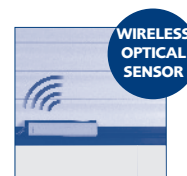

Door width

Door height	1000	1250	1500	1750	2000	2250	2500	2750	3000	3250	3500	3750	4000	4250	4500	4750	5000
1200		1743	1780	1799	1835	1870	1905	1939	1989	2254	2289	2325	2358	2392	2437	2471	2509
1500		1769	1806	1833	1873	1912	1952	1993	2045	2316	2355	2392	2431	2471	2520	2559	2599
1750		1788	1830	1863	1905	1947	1986	2029	2087	2363	2406	2448	2490	2532	2586	2626	2668
2000		1796	1838	1870	1912	1954	2000	2042	2099	2379	2421	2464	2509	2551	2604	2648	2692
2125		1806	1853	1886	1931	1976	2023	2069	2127	2411	2456	2501	2547	2591	2648	2692	2737
2250		1828	1875	1912	1960	2011	2058	2109	2170	2456	2503	2551	2599	2719	2777	2825	2874
2375		1835	1883	1922	1971	2018	2071	2119	2183	2471	2522	2570	2623	2701	2801	2851	2898
2500		1863	1915	1957	2011	2066	2119	2172	2241	2535	2589	2641	2695	-	-	-	-
2750		1886	1947	1993	2047	2109	2165	2223	2296	2668	2724	2783	2840	-	-	-	-
3100																	

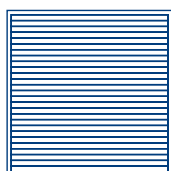

**GaraGlide 5**

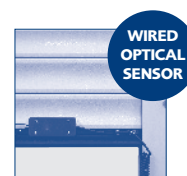

Door width

Door height	1000	1250	1500	1750	2000	2250	2500	2750	3000	3250	3500	3750	4000	4250	4500	4750	5000
1200		1844	1881	1900	1936	1971	2006	2040	2090	2355	2390	2426	2459	2493	2538	2572	2609
1500		1870	1907	1934	1974	2013	2053	2093	2146	2417	2456	2493	2532	2572	2621	2660	2700
1750		1888	1931	1964	2006	2048	2087	2130	2188	2464	2506	2549	2591	2633	2687	2727	2769
2000		1897	1939	1971	2013	2055	2101	2143	2200	2480	2522	2565	2609	2652	2705	2749	2793
2125		1907	1954	1987	2032	2077	2124	2170	2228	2512	2557	2602	2648	2692	2749	2793	2838
2250		1929	1976	2013	2060	2112	2159	2210	2271	2557	2604	2652	2700	2820	2878	2926	2975
2375		1936	1984	2023	2072	2119	2172	2220	2284	2572	2623	2671	2724	2802	2902	2951	2999
2500		1964	2016	2058	2112	2167	2220	2273	2342	2636	2690	2742	2796	-	-	-	-
2750		1987	2048	2093	2148	2210	2265	2324	2397	2769	2825	2883	2941	-	-	-	-
3100																	

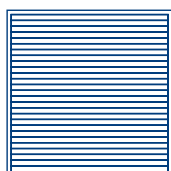

**GaraGlide 6**

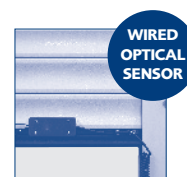

Door width

Door height	1000	1250	1500	1750	2000	2250	2500	2750	3000	3250	3500	3750	4000	4250	4500	4750	5000
1200		1888	1926	1944	1980	2015	2050	2084	2135	2399	2434	2470	2503	2537	2583	2617	2654
1500		1914	1951	1978	2018	2057	2098	2138	2190	2461	2500	2537	2577	2617	2665	2704	2744
1750		1933	1975	2008	2050	2092	2132	2174	2233	2509	2551	2593	2635	2677	2731	2771	2813
2000		1941	1983	2015	2057	2100	2145	2187	2244	2524	2566	2609	2654	2696	2750	2793	2837
2125		1951	1999	2032	2076	2121	2169	2214	2273	2556	2601	2647	2692	2736	2793	2837	2882
2250		1973	2020	2057	2105	2156	2204	2254	2315	2601	2649	2696	2744	2864	2923	2970	3019
2375		1980	2029	2068	2116	2163	2216	2264	2328	2617	2667	2716	2768	2846	2946	2996	3043
2500		2008	2060	2103	2156	2211	2264	2317	2386	2681	2734	2787	2840	-	-	-	-
2750		2032	2092	2138	2192	2254	2310	2368	2442	2813	2869	2928	2985	-	-	-	-
3100																	

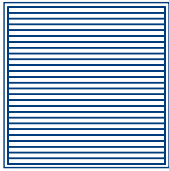

**GaraGlide 7**

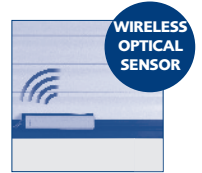

Door width

Door height	1000	1250	1500	1750	2000	2250	2500	2750	3000	3250	3500	3750	4000	4250	4500	4750	5000
1200		2017	2054	2073	2109	2144	2179	2213	2263	2528	2563	2599	2632	2666	2711	2745	2783
1500		2043	2080	2107	2147	2186	2226	2266	2319	2590	2629	2666	2705	2745	2794	2833	2873
1750		2062	2104	2137	2179	2221	2260	2303	2361	2637	2680	2722	2764	2806	2860	2900	2942
2000		2070	2112	2144	2186	2228	2274	2316	2373	2653	2695	2738	2783	2825	2878	2922	2966
2125		2080	2127	2160	2205	2250	2297	2343	2401	2685	2730	2775	2821	2865	2922	2966	3011
2250		2102	2149	2186	2234	2285	2332	2383	2444	2730	2777	2825	2873	2993	3051	3099	3148
2375		2109	2157	2196	2245	2292	2345	2393	2457	2745	2796	2844	2897	2975	3075	3124	3172
2500		2137	2189	2231	2285	2340	2393	2446	2515	2809	2863	2915	2969	-	-	-	-
2750		2160	2221	2266	2321	2383	2439	2497	2570	2942	2998	3057	3114	-	-	-	-
3100																	

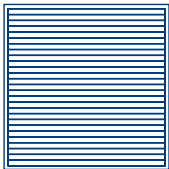

**GaraGlide 8**

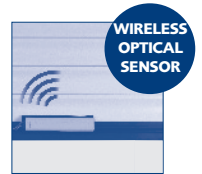

Door width

Door height	1000	1250	1500	1750	2000	2250	2500	2750	3000	3250	3500	3750	4000	4250	4500	4750	5000
1200		2062	2099	2117	2153	2188	2223	2257	2308	2572	2607	2643	2676	2710	2756	2790	2827
1500		2087	2124	2151	2191	2230	2271	2311	2363	2634	2673	2710	2750	2790	2838	2877	2917
1750		2106	2148	2181	2223	2265	2305	2347	2406	2682	2724	2766	2808	2851	2904	2944	2986
2000		2114	2156	2188	2230	2273	2318	2360	2417	2697	2739	2783	2827	2869	2923	2966	3010
2125		2124	2172	2205	2249	2294	2342	2387	2446	2729	2774	2820	2865	2909	2966	3010	3055
2250		2146	2193	2230	2278	2329	2377	2427	2488	2774	2822	2869	2917	3037	3096	3143	3192
2375		2153	2202	2241	2289	2337	2389	2437	2501	2790	2840	2889	2941	3019	3119	3169	3216
2500		2181	2234	2276	2329	2384	2437	2490	2559	2854	2907	2960	3013	-	-	-	-
2750		2205	2265	2311	2365	2427	2483	2542	2615	2986	3042	3101	3158	-	-	-	-
3100																	

**At a glance – which GaraGlide is right for me?**

Key features	Version 1	Version 2	Version 3	Version 4	Version 5	Version 6	Version 7	Version 8
2x standard handsets	•		•		•		•	
2x bisecur handsets		•		•		•		•
Wired optical sensor	•	•				•	•	
Wireless optical sensor			•	•			•	•
Manual limit setting	•	•	•	•				
Electronic limit setting					•	•	•	•

## Roller door fitting dimensions

### Fitting behind opening

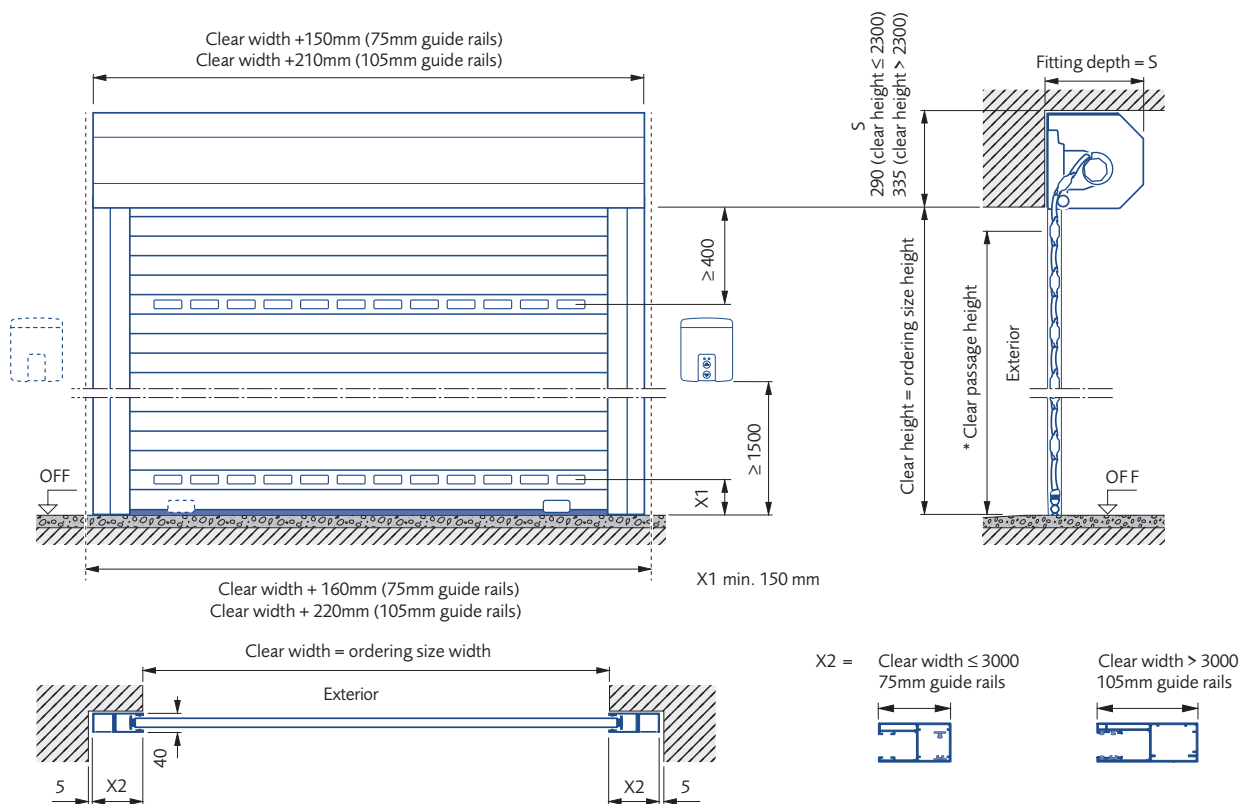

### Fitting between opening

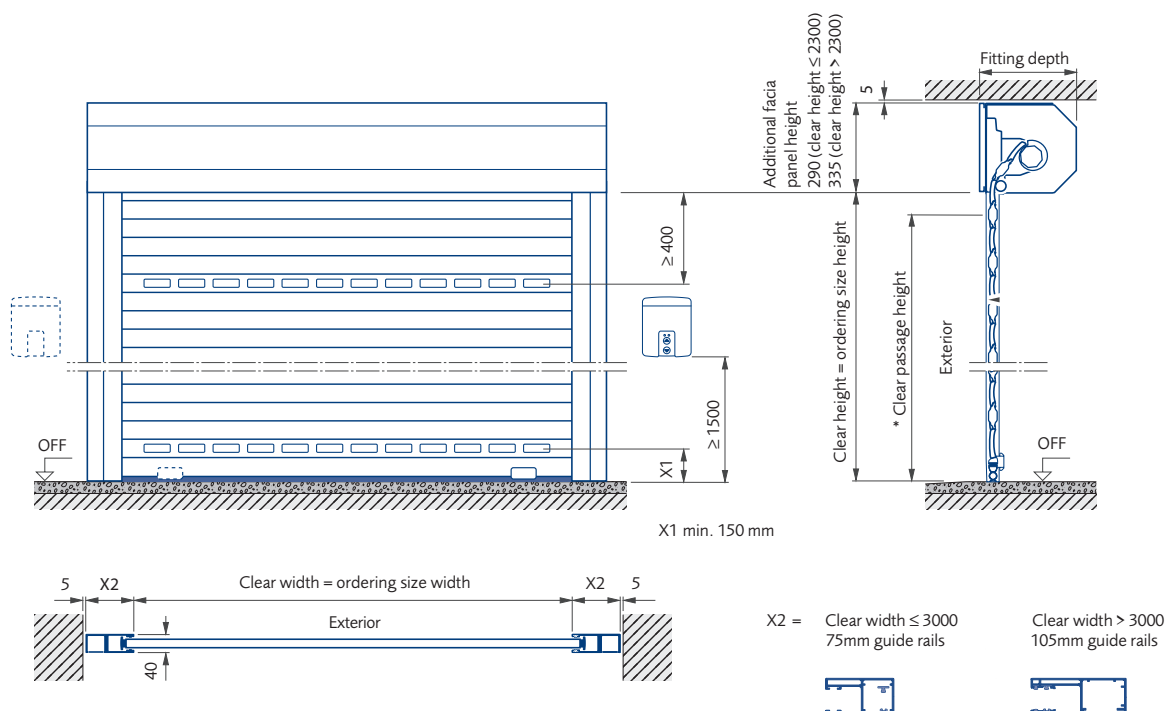

# FrontGuard 46 and FrontGuard 65 Entrance Doors

## FrontGuard Steel (FGS) Door

### Door design

Steel door leaf with foam filled core and thermal break overlapping the leaf, aluminium frame and multi-point locking. Supplied in polyester primer coating in Traffic White (RAL 9016) in a smooth finish (inside and out). Exterior and interior in the same colour.

### Insulation

FrontGuard 46 doors have a 46mm thick door panel and FrontGuard 65 doors have a 65mm thick door panel.

### Surface

Flush fitting door leaf on the interior and exterior of the door, with a leaf frame on the inside and a thick rebate. The flush fit on the interior gives the impression of a residential internal door can be optimally integrated into your house's interior.

### Colours

White (RAL 9016) as standard.

Optional colours available for all doors:

- |                           |                                  |                          |                              |
|---------------------------|----------------------------------|--------------------------|------------------------------|
| - Light Ivory (RAL 1015)  | - Moss Green (RAL 6005)          | - Dusty Grey (RAL 7037)  | - Grey White (RAL 9002)      |
| - Flame Red (RAL 3000)    | - Basalt Grey (RAL 7012)         | - Quartz Grey (RAL 7039) | - White Aluminium (RAL 9006) |
| - Ruby Red (RAL 3003)     | - Slate Grey (RAL 7015)          | - Window Grey (RAL 7040) | - Grey Aluminium (CH 907)    |
| - Purple Red (RAL 3004)   | - Anthracite Grey (RAL 7016)     | - Clay Brown (RAL 8003)  |                              |
| - Gentian Blue (RAL 5010) | - Titan Metallic finish (CH 703) | - Terra Brown (RAL 8028) |                              |
| - Pigeon Blue (RAL 5014)  | - Light Grey (RAL 7035)          | - Cream (RAL 9001)       |                              |

### Timber Effect (available for FGS 010, FGS 015, FGS 700 and FGS 900)

- |                           |            |             |                  |
|---------------------------|------------|-------------|------------------|
| - Golden Oak              | - Dark Oak | - Night Oak | - Winchester Oak |
| - Titan Metallic (CH 703) |            |             |                  |

### Matt Deluxe Colours

- |                                |                             |                            |                           |
|--------------------------------|-----------------------------|----------------------------|---------------------------|
| - Anthracite Grey (CH 7016)    | - Terra Brown (CH 8028)     | - Grey Aluminium (CH 9007) | - Traffic White (CH 9016) |
| - Anthracite Metallic (CH 703) | - White Aluminium (CH 9006) |                            |                           |

### Seals

4-sided double, black EPDM seals. Brush seal at the bottom, 20 mm high plastic threshold with thermal break.

### Locks & bolts

11-point security: 2 conical swing bolts engage with 2 additional security bolts and 1 deadbolt in the frame's lock plates. 3 further security bolts on the hinge side and three barrel hinges.

### Drip angle

Optional, Traffic White (RAL 9016). Invisible fastening and plastic cover cap at each end.

### Hinges

Three 2-piece 3-way adjustable hinges with hinge caps in aluminium look.

### Handles / Letter plates

Lever/lever handle set and letter plate in silver to choose as standard on classic designs.

Contemporary and modern designs all have fixed bar handles on the outside and therefore a key is required to open these doors from the outside at all times.

### Profile cylinder and keys

Cylinder length with fixed bar handles: 27.5 x 35.5 mm.

Cylinder length with standard lever/lever or lever/knob handle set: 31.5 x 40.5 mm.

5 keys supplied as standard, 8 or 10 keys available as an option.

### Packaging

FrontGuard doors are packed with polystyrene around the door and then shrink wrapped. Side elements are transported with glass already fitted.

### Stock availability

Made to order. Approximately 8 weeks lead-time.



### FrontGuard 46 Designs

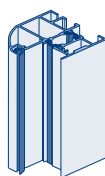
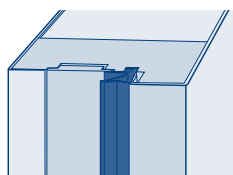

Profile A1

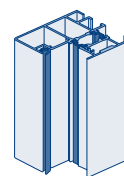

Profile A2

Size (W x H)	RAL 9016	Colour	Matt Deluxe	Timber Effect & CH 703
--------------	----------	--------	-------------	------------------------

### Modern

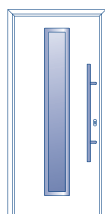

FGS 700

- 3 panes of insulated glass, exterior laminated safety glass, sand-blasted float with 7 clear strips. Interior has single-pane safety glass.
- Stainless steel glazing frame.

1000 x 2100 1100 x 2100	1745	1870	1967	1995
from 700 x 1875 up to 1250 x 2250	2132	2256	2353	2381
U <sub>D</sub> -value for size 1230 x 2180 mm: approx. 1.2 W/(m <sup>2</sup> ·K)				

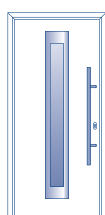

FGS 750

- 3 panes of insulated glass, exterior laminated safety glass, sand-blasted float with 5 clear strips. Interior has laminated safety glass.
- Stainless steel glazing frame.

1000 x 2100 1100 x 2100	1745	1870	1967	1995
from 875 x 1990 up to 1250 x 2250	2132	2256	2353	2381
U <sub>D</sub> -value for size 1230 x 2180 mm: approx. 1.2 W/(m <sup>2</sup> ·K)				

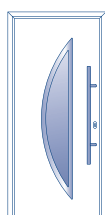

FGS 900

- 3 panes of insulated glass, exterior laminated safety glass, sand-blasted float with 4 clear strips. Interior has single-pane safety glass.
- Stainless steel glazing frame.

1000 x 2100 1100 x 2100	1797	1922	2018	2046
from 800 x 1875 up to 1250 x 2250	2183	2308	2405	2432
U <sub>D</sub> -value for size 1230 x 2180 mm: approx. 1.2 W/(m <sup>2</sup> ·K)				

### Classic



FGS 100

1000 x 2100 1100 x 2100	1308	1432	1529	-
from 875 x 1875 up to 1100 x 2186	1693	1818	1914	-
U <sub>D</sub> -value for size 1230 x 2180 mm: approx. 1.1 W/(m <sup>2</sup> ·K)				



FGS 200

- 2 panes of insulated glass: Exterior has single-pane safety glass. Interior has single pane safety Cathedral glass with small hammered finish.
- Plastic glazing frame with surface mounted rails.

1000 x 2100 1100 x 2100	1603	2015	2112	-
from 875 x 1990 up to 1100 x 2186	1988	2400	2497	-
U <sub>D</sub> -value for size 1230 x 2180 mm: approx. 1.2 W/(m <sup>2</sup> ·K)				



FGS 400

- 2 panes of insulated glass: Exterior has laminated safety glass. Interior has single pane safety Cathedral glass with small hammered finish.
- Plastic glazing frame with surface mounted rails.

1000 x 2100 1100 x 2100	1467	1879	1976	-
from 875 x 1875 up to 1100 x 2186	1853	2265	2361	-
U <sub>D</sub> -value for size 1230 x 2180 mm: approx. 1.4 W/(m <sup>2</sup> ·K)				

FrontGuard 46 Designs

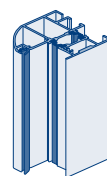
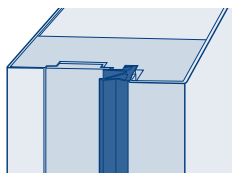

Profile A1

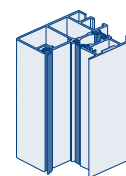

Profile A2

Size (W x H)	RAL 9016	Colour	Matt Deluxe	Timber Effect & CH 703
--------------	----------	--------	-------------	------------------------

Contemporary



FGS 010

1000 x 2100 1100 x 2100	1260	1385	1482	1510
from 700 x 1875 up to 1250 x 2250	1645	1770	1867	1895
U <sub>D</sub> -value for size 1230 x 2180 mm: approx. 1.1 W/(m <sup>2</sup> ·K)				



FGS 015

1000 x 2100 1100 x 2100	1308	1432	1529	1557
from 875 x 1875 up to 1250 x 2250	1693	1818	1914	1942
U <sub>D</sub> -value for size 1230 x 2180 mm: approx. 1.1 W/(m <sup>2</sup> ·K)				



FGS 515

1000 x 2100 1100 x 2100	1308	1432	1529	1557
from 700 x 1875 up to 1250 x 2250	1693	1818	1914	1942
U <sub>D</sub> -value for size 1230 x 2180 mm: approx. 1.1 W/(m <sup>2</sup> ·K)				



FGS 020

- 2 panes of insulated glass, exterior laminated safety glass and interior single-pane safety glass satinato.
- Plastic glazing frame in door leaf colour (excludes timber effects).

1000 x 2100 1100 x 2100	1520	1932	2029	2057
from 700 x 1875 up to 1250 x 2250	1906	2318	2415	2444
U <sub>D</sub> -value for size 1230 x 2180 mm: approx. 1.4 W/(m <sup>2</sup> ·K)				



FGS 025

- 2 panes of insulated glass, exterior laminated safety glass and interior single-pane safety glass satinato.
- Plastic glazing frame in door leaf colour (excludes timber effects).

1000 x 2100 1100 x 2100	1603	2015	2112	2141
from 875 x 1875 up to 1250 x 2250	1988	2400	2497	2526
U <sub>D</sub> -value for size 1230 x 2180 mm: approx. 1.4 W/(m <sup>2</sup> ·K)				



FGS 030

- 2 panes of insulated glass, exterior laminated safety glass and interior single-pane safety glass satinato.
- Plastic glazing frame in door leaf colour (excludes timber effects).

1000 x 2100 1100 x 2100	1745	2157	2254	2283
from 700 x 1875 up to 1250 x 2250	2132	2544	2640	2669
U <sub>D</sub> -value for size 1230 x 2180 mm: approx. 1.3 W/(m <sup>2</sup> ·K)				



FGS 040

- 2 panes of insulated glass, exterior laminated safety glass and interior single-pane safety glass satinato.
- Plastic glazing frame in door leaf colour (excludes timber effects).

1000 x 2100 1100 x 2100	1520	1932	2029	2057
from 700 x 1875 up to 1250 x 2250	1906	2318	2415	2444
U <sub>D</sub> -value for size 1230 x 2180 mm: approx. 1.2 W/(m <sup>2</sup> ·K)				

## FrontGuard 46 Designs – Side elements and transom lights

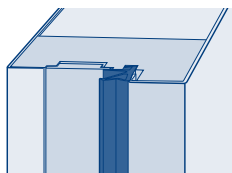

Ordering sizes Overall frame (W x H)	Glass	RAL 9016	Colour	Matt Deluxe	Timber Effect & CH 703
---	-------	----------	--------	-------------	------------------------

### Side Element

#### Fixed side element assembly

- Not possible for door assemblies opening outwards!
- Not possible in conjunction with RC 2!

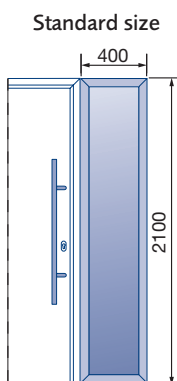

Standard size 400 x 2100	Clear	817	949	1038	992
	Satinato	817	949	1038	992
	Cathedral glass	817	949	1038	992
	Sand-blasted	817	949	1038	992
	Sand-blasted with clear stripes	1378	1509	1038	1553

### Side Element

#### Fixed side element assembly

- Not possible for door assemblies opening outwards!
- Not possible in conjunction with RC 2!

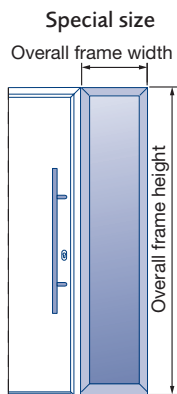

Special size Overall frame width Overall frame height	From 300 x 700 Up to 500 x 2250	Clear, Satinato, cathedral glass or sand-blasted	1017	1150	1238	1192
	Up to 1000 x 2250 <sup>1</sup>		1214	1347	1435	1390
	From 300 x 1875 Up to 500 x 2250	Sand-blasted with clear stripes	1725	1857	1945	1900
	Up to 1000 x 2250 <sup>1</sup>		1920	2052	2141	2096

<sup>1</sup> Only possible without transom light  
Door set with side element does not contribute to the static equilibrium.  
Statics must be ensured by the building structure.

### Transom light

#### Fixed transom light assembly

- Not possible for door assemblies opening outwards!
- Not possible in conjunction with RC 2!

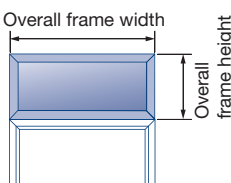





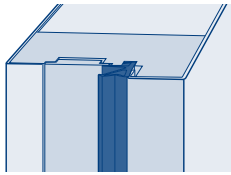







Overall frame width Overall frame height	From 700 x 300 Up to 1250 x 500	Clear, Satinato, cathedral glass or sand-blasted	768	901	989	944
	Up to 2250 x 500		1017	1150	1238	1192

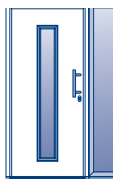

FrontGuard 46 Designs – Overview of panels / glass for side elements



Infill / size range  
Glass design: Exterior pane clear laminated safety glass – interior pane

	Style	Glass(interior pane)	Size range					
			Side element	Transom light				
Modern	 FGS 700  FGS 750	<ol style="list-style-type: none"> <li>1. Clear laminated safety glass / sand-blasted laminated safety glass (without clear stripes)</li> <li>2. Clear laminated safety glass / clear laminated safety glass</li> </ol>	Width 300 - 1000 mm	Width 875 - 2250 mm				
	 FGS 900				Height 1990 - 2250 mm	Height 300 - 500 mm		
Contemporary	 FGS 010  FGS 015  FGS 515	<ol style="list-style-type: none"> <li>1. Clear laminated safety glass / Mastercarré single-pane safety glass</li> <li>2. Clear laminated safety glass / single-pane safety ornamental glass 504</li> <li>3. Clear laminated safety glass / sand-blasted laminated safety glass (without clear stripes)</li> <li>4. Clear laminated safety glass / clear laminated safety glass</li> </ol>	Width 300 - 1000 mm	Width 700 - 2250 mm				
	 FGS 020  FGS 025  FGS 030				Height 1875 - 2250 mm	Height 300 - 500 mm		
	 FGS 040						Width 300 - 1000 mm	Width 875 - 2250 mm
Classic	 FGS 100  FGS 200	<ol style="list-style-type: none"> <li>1. Element with 3 panels</li> <li>2. Clear laminated safety glass / clear laminated safety glass</li> <li>3. Clear laminated safety glass / single-pane safety cathedral glass</li> </ol>	Width panel 450 mm, width glass 300 - 1000 mm	Width 875 - 2250 mm				
	 FGS 400				Height 1875 - 2186 mm	Height 300 - 500 mm		
							Width panel 450 mm, width glass 300 - 1000 mm	Width 875 - 2250 mm
	Height 1875 - 2186 mm	Height 300 - 500 mm						

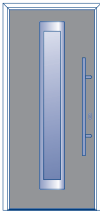
### FrontGuard 46 Designs – Door leaf and frame in different colours/surfaces

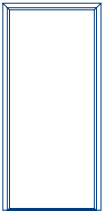
Colours of Leaf and frame differ			Door leaf	Frame	Price for entrance door with surface
 <p>Example</p>  <p>Door leaf Anthracite grey</p>  <p>Frame Traffic white</p>	RAL 9016	Color	Color		
	RAL 9016	Timber effect / CH 703	Timber effect / CH 703		
	Color	RAL 9016	Timber effect / CH 703		
	Color	Timber effect / CH 703	Timber effect / CH 703		
	Timber effect / CH 703	RAL 9016	Timber effect / CH 703		
	Timber effect / CH 703	Timber effect / CH 703	Timber effect / CH 703		

### FrontGuard 46 Designs – Bottom Spacer Profile

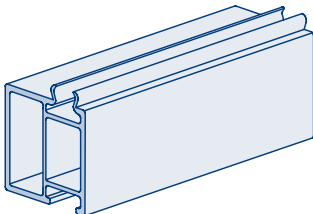
 <p>Bottom spacer profile</p>	Length up to 1250 mm	Height		Each	
		Height	30 mm	Each	28
Length up to 2250 mm	Height	60 mm	Each	55	
	Height	90 mm	Each	83	
	Height	120 mm	Each	110	
	Height	150 mm	Each	136	
	Height	30 mm	Each	46	
Length up to 3250 mm	Height	60 mm	Each	91	
	Height	90 mm	Each	136	
	Height	120 mm	Each	182	
	Height	150 mm	Each	227	
	Height	30 mm	Each	65	
Length up to 3250 mm	Height	60 mm	Each	130	
	Height	90 mm	Each	194	
	Height	120 mm	Each	259	
	Height	150 mm	Each	324	

### FrontGuard 46 Designs – Extension profile

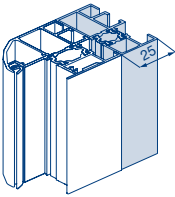
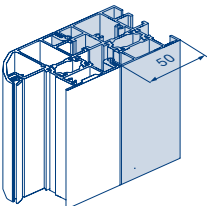
Extension profile 25 mm Dimensions (W x D): 25 x 60.5 mm					
		RAL 9016	Color	Matt Deluxe	Timber Effect & CH 703
	per m	57	68	80	80
Extension profile 50 mm Dimensions (W x D): 50 x 60.5 mm					
		RAL 9016	Color	Matt Deluxe	Timber Effect & CH 703
	per m	63	75	86	86

FrontGuard 65 Designs

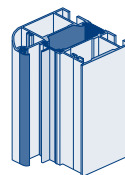
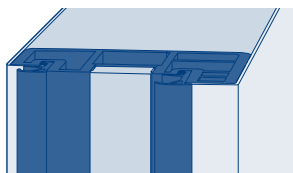

Profile A3

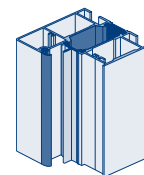

Profile A4

Size (W x H)	RAL 9016	Colour	Matt Deluxe	Timber Effect & CH 703
--------------	----------	--------	-------------	------------------------

Modern



FGS 600

- Insulated glass: Exterior has single-pane safety glass Satinato, edge with silkscreen clear-float/ single pane safety glass. Interior has single-pane safety glass Satinato, edged with Silkscreen, surface mounted exterior pane.

1000 x 2100				
1100 x 2100	2998	3123	3219	3247
from 700 x 1875				
up to 1250 x 2250	3384	3509	3606	3633
U <sub>D</sub> -value for size 1230 x 2180 mm: approx. 1.0 W/(m <sup>2</sup> ·K)				



FGS 700

- 3 panes of insulated glass: Exterior has laminated safety glass, sand-blasted float with 7 clear stripes. Interior has single-pane safety glass. - Stainless steel glazing frame.

1000 x 2100				
1100 x 2100	2677	2801	2898	2926
from 700 x 1875				
up to 1250 x 2250	3063	3187	3284	3312
U <sub>D</sub> -value for size 1230 x 2180 mm: approx. 0.98 W/(m <sup>2</sup> ·K)				



FGS 750

- 3 panes of insulated glass: Exterior has laminated safety glass, sand-blasted float with 5 clear stripes. Interior has single-pane safety glass. - Stainless steel glazing frame.

1000 x 2100				
1100 x 2100	2677	2801	2898	2926
from 875 x 1990				
up to 1250 x 2250	3063	3187	3284	3312
U <sub>D</sub> -value for size 1230 x 2180 mm: approx. 0.95 W/(m <sup>2</sup> ·K)				



FGS 800

- 3 panes of insulated glass: Exterior has laminated safety glass, Satinato. Interior has laminated safety glass. - Stainless steel glazing frame.

1000 x 2100				
1100 x 2100	2867	2992	3089	3116
from 875 x 1990				
up to 1250 x 2250	3252	3377	3474	3502
U <sub>D</sub> -value for size 1230 x 2180 mm: approx. 0.93 W/(m <sup>2</sup> ·K)				

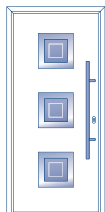

FGS 810

- 3 panes of insulated glass: Exterior has laminated safety glass, sand-blasted float with clear stripes (square). Interior has single-pane safety glass. - Stainless steel glazing frame.

1000 x 2100				
1100 x 2100	2867	2992	3089	3116
from 875 x 1990				
up to 1250 x 2250	3252	3377	3474	3502
U <sub>D</sub> -value for size 1230 x 2180 mm: approx. 0.97 W/(m <sup>2</sup> ·K)				



FGS 820

-3 panes of insulated glass: Exterior has laminated safety glass, Satinato. Interior has laminated safety glass. - Stainless steel glazing frame.

1000 x 2100				
1100 x 2100	2867	2992	3089	3116
from 875 x 1990				
up to 1250 x 2250	3252	3377	3474	3502
U <sub>D</sub> -value for size 1230 x 2180 mm: approx. 0.95 W/(m <sup>2</sup> ·K)				

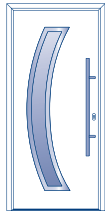

FGS 850

- 3 panes of insulated glass: Exterior has laminated safety glass, sand-blasted float with 7 clear stripes. Interior has laminated safety glass. - Stainless steel glazing frame.

1000 x 2100				
1100 x 2100	3091	3215	3312	3340
from 875 x 1990				
up to 1250 x 2250	3477	3601	3698	3726
U <sub>D</sub> -value for size 1230 x 2180 mm: approx. 0.97 W/(m <sup>2</sup> ·K)				

### FrontGuard 65 Designs

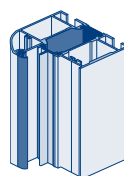
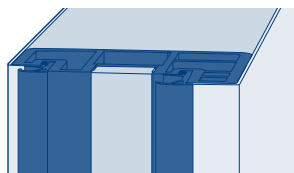

Profile A3

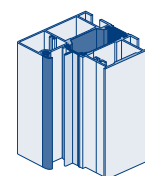

Profile A4

Size (W x H)	RAL 9016	Colour	Matt Deluxe	Timber Effect & CH 703
--------------	----------	--------	-------------	------------------------

### Modern

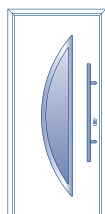

FGS 900

- 3 panes of insulated glass:  
Exterior has laminated safety glass, sand-blasted float with 4 clear stripes. Interior has laminated safety glass.
- Stainless steel glazing frame.

1000 x 2100 1100 x 2100	2867	2992	3089	3116
from 800 x 1875 up to 1250 x 2250	3252	3377	3474	3502

U<sub>D</sub>-value for size 1230 x 2180 mm: approx. 0.96 W/(m<sup>2</sup>·K)

### Classic



FGS 410

1000 x 2100 1100 x 2100	2860	3272	3369	-
from 875 x 1875 up to 1100 x 2186	3246	3658	3755	-

U<sub>D</sub>-value for size 1230 x 2180 mm: approx. 1.0 W/(m<sup>2</sup>·K)



FGS 430

1000 x 2100 1100 x 2100	2860	3272	3369	-
from 875 x 1990 up to 1100 x 2186	3246	3658	3755	-

U<sub>D</sub>-value for size 1230 x 2180 mm: approx. 1.0 W/(m<sup>2</sup>·K)

### Contemporary



FGS 010

1000 x 2100 1100 x 2100	1742	1867	1964	1992
from 700 x 1875 up to 1250 x 2250	2128	2252	2349	2377

U<sub>D</sub>-value for size 1230 x 2180 mm: approx. 0.87 W/(m<sup>2</sup>·K)

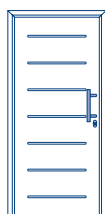

FGS 015

1000 x 2100 1100 x 2100	1830	1954	2051	2079
from 875 x 1875 up to 1250 x 2250	2216	2341	2438	2465

U<sub>D</sub>-value for size 1230 x 2180 mm: approx. 0.87 W/(m<sup>2</sup>·K)



FGS 515

1000 x 2100 1100 x 2100	1830	1954	2051	2079
from 700 x 1875 up to 1250 x 2250	2216	2341	2438	2465

U<sub>D</sub>-value for size 1230 x 2180 mm: approx. 0.87 W/(m<sup>2</sup>·K)

FrontGuard 65 Designs

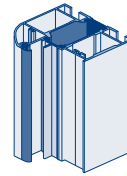
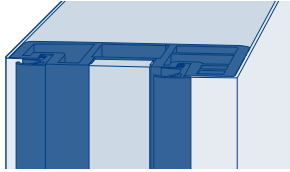

Profile A3

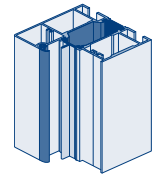

Profile A4

Size (W x H)	RAL 9016	Colour	Matt Deluxe	Timber Effect & CH 703
--------------	----------	--------	-------------	------------------------

Modern – Models with one-way plate glass



FGS 700N

- 3 panes of insulated glass:  
Exterior has laminated safety glass, one-way plate glass.  
Interior has single-pane safety glass.
- Stainless steel glazing frame.

1000 x 2100	2677	2801	2898	2926
1100 x 2100				
from 700 x 1875	3063	3187	3284	3312
up to 1250 x 2250				

U<sub>D</sub>-value for size 1230 x 2180 mm: approx. 0.98 W/(m<sup>2</sup>·K)

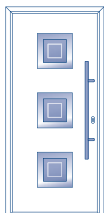

FGS 810N

- 3 panes of insulated glass:  
Exterior has laminated safety glass, one-way plate glass.  
Interior has single-pane safety glass.
- Stainless steel glazing frame.

1000 x 2100	2867	2992	3089	3116
1100 x 2100				
from 875 x 1990	3252	3377	3474	3502
up to 1250 x 2250				

U<sub>D</sub>-value for size 1230 x 2180 mm: approx. 0.97 W/(m<sup>2</sup>·K)



## FrontGuard 65 Designs – Side elements and transom lights

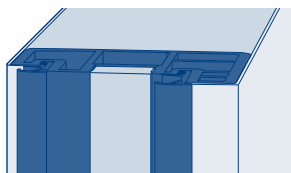

Ordering sizes Overall frame (W x H)	Glass	RAL 9016	Colour	Matt Deluxe	Timber Effect & CH 703
---	-------	----------	--------	-------------	------------------------

### Side Element

Fixed side element assembly

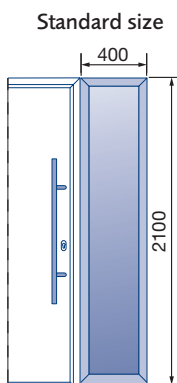

Standard size 400 x 2100	Clear	1038	1170	1258	1213
	Satinato	1038	1170	1258	1213
	Sand-blasted	1038	1170	1258	1213
	Sand-blasted with clear stripes	1599	1731	1819	1774
	One-way plate glass	1188	1320	1408	1363

### Side Element

Fixed side element assembly

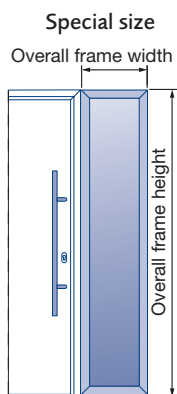

Special size Overall frame width Overall frame height	From 300 x 700 Up to 500 x 2250	Clear, Satinato, cathedral glass or sand-blasted	1238	1370	1459	1414
	Up to 1000 x 2250 <sup>1</sup>		1435	1567	1656	1610
	From 300 x 700 Up to 500 x 2250	One-way plate glass	1388	1520	1609	1564
	Up to 1000 x 2250 <sup>1</sup>		1567	1699	1788	1743
	From 300 x 1875 Up to 500 x 2250	Sand-blasted with clear stripes	1946	2079	2167	2122
	Up to 1000 x 2250 <sup>1</sup>		2142	2275	2363	2318

<sup>1</sup> Only possible without transom light  
Door set with side element does not contribute to the static equilibrium.  
Statics must be ensured by the building structure.

### Transom light

Fixed transom light assembly

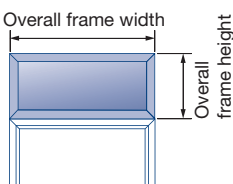



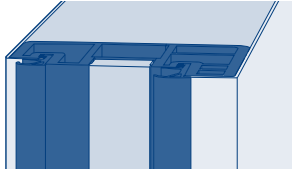

Overall frame width Overall frame height	From 700 x 300 Up to 1250 x 500	Clear, Satinato, cathedral glass or sand-blasted	834	967	1054	1009
	Up to 1750 x 500		1005	1138	1225	1180
	Up to 2250 x 500		1236	1369	1458	1413
	From 700 x 300 Up to 1250 x 500	One-way plate glass	984	1117	1204	1159
	Up to 1750 x 500		1139	1272	1359	1314
	Up to 2250 x 500		1350	1483	1570	1525

FrontGuard 65 Designs – Overview of panels / glass for side elements



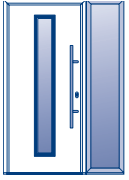
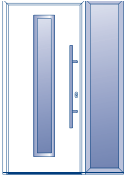
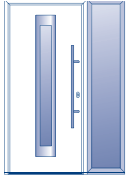
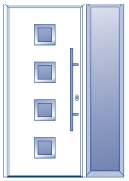
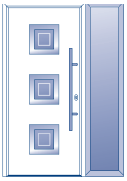

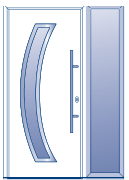
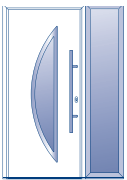
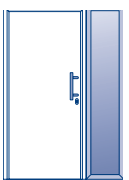
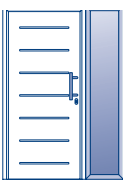
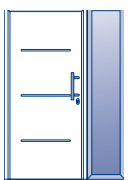
**Infill / size range**

Glass design: Exterior pane clear laminated safety glass – intermediate pane – interior pane clear laminated safety glass

	Style	Glass(interior pane)	Size range	
			Side element	Transom light
Modern	   FGS 600    FGS 700    FGS 750	1. Clear laminated safety glass / sand-blasted laminated safety glass (without clear stripes) 2. Clear laminated safety glass / clear laminated safety glass	Width 300 - 1000 mm  Height 1990 - 2250 mm	Width 875 - 2250 mm  Height 300 - 500 mm
	   FGS 800    FGS 810    FGS 820			
	  FGS 850    FGS 900			
Contemporary	   FGS 010    FGS 015    FGS 515	1. Clear laminated safety glass / Mastercarré single-pane safety glass 2. Clear laminated safety glass / single-pane safety ornamental glass 504 3. Clear laminated safety glass / sand-blasted laminated safety glass (without clear stripes) 4. Clear laminated safety glass / clear laminated safety glass	Width 300 - 1000 mm  Height 1875 - 2250 mm	Width 700 - 2250 mm  Height 300 - 500 mm
Classic	  FGS 410    FGS 430	1. Clear laminated safety glass/ sand blasted float without clear stripes/ clear laminated safety glass 2. Clear laminated safety glass/ float/ clear laminated safety glass	Width 300 - 1000 mm  Height 1875 - 2186 mm	Width 875 - 2000 mm  Height 300 - 500 mm

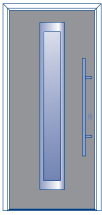
### FrontGuard 65 Designs – Door leaf and frame in different colours/surfaces

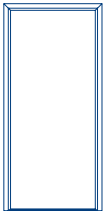
Colours of Leaf and frame differ			Door leaf	Frame	Price for entrance door with surface
			RAL 9016	Color	Color
			RAL 9016	Matt deluxe	Matt deluxe
			RAL 9016	Timber effect / CH 703	Timber effect / CH 703
			Color	RAL 9016	Color
			Color	Matt deluxe	Matt deluxe
			Color	Timber effect / CH 703	Timber effect / CH 703
			Matt deluxe	RAL 9016	Matt deluxe
			Matt deluxe	Color	Matt deluxe
			Matt deluxe	Timber effect / CH 703	Timber effect / CH 703
			Timber effect / CH 703	RAL 9016	Timber effect / CH 703
			Timber effect / CH 703	Matt deluxe	Timber effect / CH 703
			Timber effect / CH 703	Color	Timber effect / CH 703

### FrontGuard 65 Designs – Two-Colour entrance doors, side elements or transom light

Door leaf and frame / side element / transom light:  
 - Exterior finishes in decors Golden Oak, Dark Oak or Titan Metallic CH 703.  
 - Interior in Traffic white RAL 9016.  
 For frame profile A3.  
 Opening inwards.  
 Not possible for styles FGS 100, FGS 410 and FGS 430.

Surcharge for version with decor surface		
Per door	Per side element	Per transom light
129	61	61

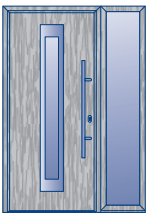
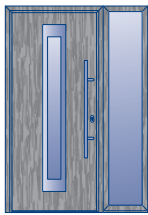
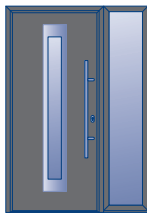
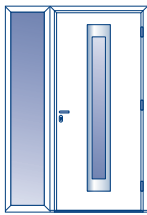
Exterior entrance door / side element			Interior
			
Golden Oak	Dark Oak	Titan Metallic CH 703	Traffic white RAL 9016

### FrontGuard 65 Designs – Bottom Spacer Profile

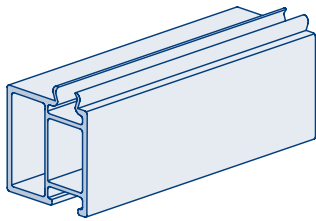

Bottom spacer profile

Length up to 1250 mm	Height	30 mm	Each	28
	Height	60 mm	Each	55
	Height	90 mm	Each	83
	Height	120 mm	Each	110
	Height	150 mm	Each	136
Length up to 2250 mm	Height	30 mm	Each	46
	Height	60 mm	Each	91
	Height	90 mm	Each	136
	Height	120 mm	Each	182
	Height	150 mm	Each	227
Length up to 3250 mm	Height	30 mm	Each	65
	Height	60 mm	Each	130
	Height	90 mm	Each	194
	Height	120 mm	Each	259
	Height	150 mm	Each	324

### FrontGuard 65 Designs – Extension profile

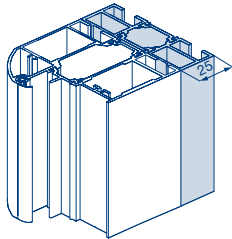

Extension profile 25 mm  
Dimensions (W x D): 25 x 80 mm

	RAL 9016	Color	Matt Deluxe	Timber Effect & CH 703
per m	63	75	86	86

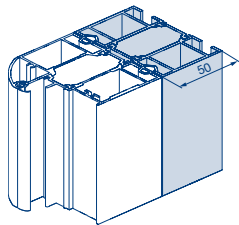

Extension profile 50 mm  
Dimensions (W x D): 50 x 80 mm

	RAL 9016	Color	Matt Deluxe	Timber Effect & CH 703
per m	68	80	91	-

## FrontGuard Door Specifications

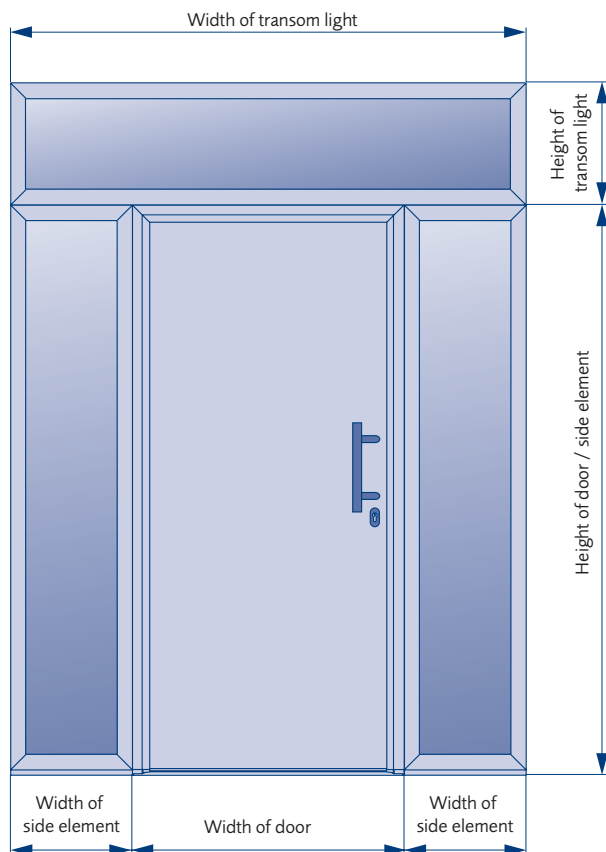

Side view of door

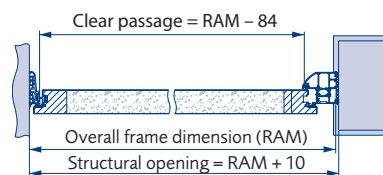

Plan view of door

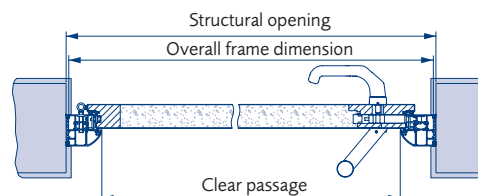

Plan view of door with side element

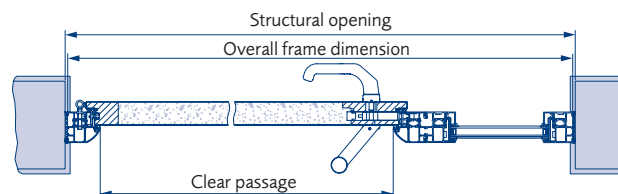

Roundstyle frame

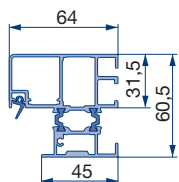

Quadrangular frame

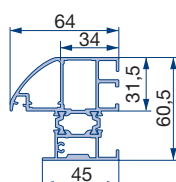

Plan view of door with side element

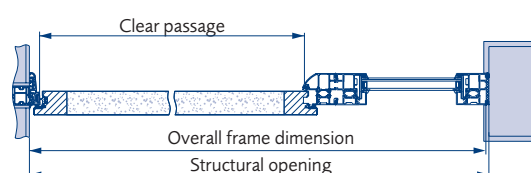

## Optional extras

Aluminium letter plate in gold or silver (only available on Classic Range)	54
Outside knob / inside lever in silver (only available on Classic Range)	137
Spyhole in chrome (for fitting on site, door leaf supplied undrilled). The hole for the spyhole needs to be drilled onsite and the kit needs to be fitted manually.	55
Profile cylinder complete (35.5 + 27.5 mm), supplied with 8 keys	53
Profile cylinder complete (35.5 + 27.5 mm), supplied with 10 keys	62
Electric strike with day catch (separate)	103
Large brushed stainless steel handle (surcharge for standard bar handle)	137
Stainless steel cleaner and care product (150 ml)	34
Option of door opening outwards	82

# User Information / Care

A Garador garage door needs only a minimum level of preparation and maintenance to give years of trouble-free service. Below is a guide to how to get the best from your garage door.

## Operation

- For opening the door in manual operation use only the outside handle or inside handle. Never use the pull rope during the opening cycle of the door.
- For closing the door from the outside – the pull rope fixed to the internal handle is only designed to pull the door towards you whilst standing within the entrance of the garage until the door can be pushed down by hand, then using the external handle for final closing.
- For closing the door from the inside – the pull rope already mentioned is designed to be pulled away from you, when facing the front entrance of the garage, until the internal handle is able to be reached, by hand, and used for final closing. The pull rope is not designed to be used for any other part of the operating cycle, or any other purpose. Failure to comply with the above instructions may result in injury to persons or property.
- When the door is operated from either outside or inside, check the area through which the door will travel is clear from people and objects. Failure to do so may result in injury to persons or property.
- When closing, ensure the latches engage properly.
- If the door is power-operated always try to ensure you match the door with a GaraMatic electric operator.

## Power Operated Garage Doors

- It is against the Law to install a power operated garage door in the UK without complying with The Machinery Directive.
- To comply with the Machinery Directive both the door and the operator used in the Installation must have a declaration of Incorporation from the manufacturer.  
On completion of the installation the Installer must provide a Declaration of conformity and apply a CE mark giving details of the installation to the door/operator combination, which is now classed as a machine.
- The Installer must issue to the Customer a declaration of conformity on the completion of the installation.
- The Installer must hold copies of both the Declarations of Incorporation and the Declaration of Conformity on a technical file for inspection by the relevant authorities.
- If any of the above requirements are not fulfilled the Installation is illegal.
- Please ensure for your own safety and peace of mind that whoever installs your electric operator is both willing and able to fulfil these requirements; if they are not do not use them !!
- Members of the DHF CAN and WILL install your operator safely and legally.

## Cleaning

- The door and frame if applicable, should be washed with a mild soap-based solution on a regular basis to prevent the build up of dirt, salts and other corrosive substances and help maintain the aesthetic appearance of the product.
- If the door is installed in a coastal location, the door panel and frame should be cleaned in this way at least every two months.
- We also suggest that all other components be brushed down on a regular basis to prevent the build up of dirt and dust etc.
- On GaraRoll roller doors regular removal of dirt and debris is required to avoid damage to laths when the curtain rolls.

## Locking

- If the key is turned completely, the door is then locked or unlocked; when unlocked it is then possible to open and close the door by turning the handle.
- If the key is turned 1/4 of the way, the door opened and then the key returned to its start position, the door will re-lock when closed.
- By moving the internal locking "snib", it is possible to lock and unlock the door from the inside without using the key, except on SBD doors where there is no internal snib/locking system.

## Maintenance

- If in doubt about any of these maintenance procedures below always consult a Garador specialist. Garador Ltd. has a nationwide network of installers who will be able to offer you a regular maintenance service on your garage door. Please call Garador or refer to the Garador website for further details of your nearest installer.
- Immediately after the door is fitted and after every 5,000 operations of the door, or at least once a year, oil all pivot points, check screws and clamped connections for tightness, keep the running tracks clean (do not grease them), check parts and replace any worn components where necessary.
- The springs should be replaced after approx. 25,000 operations by an experienced door fitter (see fitting and operation instructions).
- Do not oil the lock cylinder; if it is sticking, only lubricate with graphite dust.
- For canopy doors only, check the cable every 6 months with normal usage (8 operations per day). Have the cables replaced by an expert if any wear is found.

#### **Finish – Steel Doors**

The coating process applied to the door and chassis is environmentally friendly. Minor scratches or marks are not covered under the conditions of our warranty and should be repaired immediately to prevent corrosion and deterioration of the panel. Corrosive substances such as acids, alkalines, and salts, etc. should be cleaned from the door immediately; failure to do so will result in deterioration of the finish, which will not be covered under our warranty. Garador steel doors are finished products. They do not require immediate painting on-site. They are however not immune to damage, which can occur at any stage of the handling of the product from factory to site. Should deterioration of the finish start to occur you will need to repaint your door immediately. Prepare the surface lightly with wet and dry. Then treat with solvent based 2 pack epoxy wash primer and a normal commercial paint (cellulose paint must not be used).

Minor surface damage can easily be repaired using touch up sprays or paint sticks without invalidating your warranty.

#### **Finish – Timber Doors**

Timber panels are coated with a neutralising base-stain. Doors must be stored upright, under cover in a dry location, with wrapping intact, until wrapping is removed. As soon as the door is unwrapped, one coat of a good quality basecoat primer must be applied to both sides of the door. Immediately after installation, your timber doors require a further two coats of a good quality exterior wood finish on both sides.

Initial application and periodic treatment should be carried out strictly in accordance with the woodstain manufacturer's instructions.

Failure to follow these instructions will result in early deterioration of the timber panel which would not be covered under our warranty.

#### **Finish – GRP Doors**

GRP door panels should be periodically washed down using water. This should be done more frequently if fitted in a coastal location.

Bird droppings will bleach the finish on GRP and should be removed using water as soon as possible.

GRP doors should not be painted over.

# Warranty

Garador products are manufactured to the highest quality standards and leave our factory only after rigorous quality testing. However, if you should have grounds for complaint, this section tells you what our door warranty offers, and how to go about making your claim.

In the unlikely event of a warranty claim becoming necessary, please contact the dealer or distributor who originally supplied your garage door. Your dealer should then supply details of the claim, together with a copy of the warranty card provided with the door and proof of purchase to the Warranty Department at Garador Ltd.

To enable your claim under warranty to be processed as quickly as possible, you should provide the following details:

- 1 Your name, address and telephone number
- 2 Original invoice with date of purchase
- 3 Product description/door type and product number
- 4 Description of defect

An assessment of the claim will then be made. This may require Garador to inspect the product in-situ. In the event that there is no legitimate warranty claim under the terms specified herein, you may be liable for the costs of the inspection visit. We strongly recommend that you take note of the care and usage instructions displayed on the stickers on the back of your garage door and on the previous page and that you follow these instructions throughout.

## Garador installers

Garador Ltd. has a nationwide network of recommended installers who will be able to offer you a regular maintenance service on your garage door. Please call us on 01935 443722 or refer to the Garador website for further details of your nearest installer.

## Garador Garage Door Warranty

### Warranty Period

The purchaser is granted a warranty covering the safe and reliable function of the Garador garage door for a period of 10 years from the date of purchase. A 5 year warranty applies to springs, wire cables, track rollers, hinges and guide rollers. The warranty period for replacement parts is 6 months or to the end of the current warranty period, whichever is longer.

In the case of foil-coated timber effect and PVC doors, a warranty of 5 years is granted, for timber and GRP doors a warranty of 2 years is granted on the door panels alone under the terms and conditions specified herein. The door mechanism and steel frame (if applicable) is covered by the 10 year warranty period.

### Requirements

Warranty claims are only applicable in the country where the garage door was purchased. The product must have been purchased through our authorised distribution channels. The warranty only covers damage to the contract object. The fully completed warranty card together with the receipt of purchase correspondingly dated substantiates your right to claim under the warranty.

### Performance

During the warranty period we undertake to rectify any and all defects to the Garador product which can be proved to be attributed to a material or manufacturing fault.

We pledge at our discretion either to exchange the defective merchandise for faultless merchandise, repair it or allow a reduction in price. We do not accept costs for dismantling and installation nor for carriage.

Replaced parts become our property.

The warranty does not cover damage caused through:

- normal wear and tear
- improper installation
- negligent care and maintenance
- improper initial and subsequent operation
- negligent or wanton destruction
- external influences such as fire, water, salts, alkaline solutions, acids, abnormal environmental influences
- mechanical damage through improper transport and fitting
- priming and other surface protection treatments
- incorrect or too late applied surface protection treatments
- repair by non-qualified persons
- using non-Garador parts without the approval of the manufacturer
- Removal of the product number or making it unidentifiable

### Warranty GaraRoll

GaraRoll roller doors are subject to a limited 10 year warranty. The design of these doors represents state of the art technology. Pressure marks and abrasive wear, particularly on the top profiles are a condition of the design and cannot be avoided. They are not considered a reason for complaint. In order to avoid excessive friction, remove any dirt and debris from the door curtain at regular intervals. For motors and controls, see warranty below.



### Warranty GaraGlide

In addition to the statutory warranty provided by the dealer in the sales contract, we grant the following warranty for parts from the date of purchase:

- 5 years on operator technology, motor and motor control.
- 2 years on radio equipment, accessories and special systems.

Claims made under the warranty do not extend the warranty period. For replacement parts and repairs the warranty period is six months or at least the remainder of the warranty period.

#### General wear and tear:

Due to the design of the roller door, the inside of the door curtain will exhibit some marks after a short period of time. This is classed as general wear and tear that you would expect to see over a period of months or years. It is not detrimental to the door's performance and would therefore not be grounds for a warranty claim.

#### Pre-requisites:

The warranty claim only applies in the country where the equipment was purchased. The product must have been purchased through our authorised distribution channels. A claim under this warranty exists only for damage to the object of the contract itself. The receipt of purchase substantiates your right to claim under the warranty.

#### Services:

For the duration of the warranty we shall eliminate any product defects that are proven to be attributable to a material or manufacturing fault. We pledge to replace free of charge and at our discretion the defective goods with non-defective goods, to carry out repairs, or to grant a price reduction. Replaced parts become our property. Reimbursement of expenditure for dismantling and fitting, testing of parts as well as demands for lost profits and compensation for damages are excluded from the warranty.

Damage caused by the following is also excluded:

- improper fitting and connection
- improper initial start-up and operation
- external factors such as fire, water, abnormal environmental conditions
- mechanical damage caused by accidents, falls, impacts
- negligent or intentional destruction
- normal wear or deficient maintenance
- repairs conducted by unqualified persons
- use of non-original parts
- removal or defacing of the data label

### Electric Operator Warranty

A separate 5 year warranty is granted on our electric operators. This includes operator mechanics, motor and motor control systems. A 2 year warranty is granted on radio equipment, accessories and system controls. There is no warranty on consumables (e. g. fuses, batteries, bulbs etc.).

For further details please contact us on 01935 443722, or through our website on [www.garador.co.uk](http://www.garador.co.uk)

## Garador FrontGuard Warranty

### Warranty Period

The purchaser is granted a warranty covering mechanical parts for a period of 5 years from the date of purchase. The warranty period for replacement parts is 6 months, however, at least the current warranty period.

### Requirements

Warranty claims are only applicable in the country where the entrance door was purchased. The product must have been purchased through our authorised distribution channels. The warranty only covers damage to the contract object. The receipt of purchase correspondingly dated and signed by the dealer substantiates your right to claim under warranty.

### Performance

During the warranty period we undertake to rectify any and all defects to the Garador product which can be proved to be attributed to a material or manufacturing fault. We pledge at our discretion to either exchange the defective merchandise for faultless merchandise, repair it or allow a reduction in price. We do not accept costs for dismantling and installation nor for carriage. Replaced parts become our property.

The warranty does not cover damage caused through:

- improper installation and negligent care and maintenance
- improper initial and subsequent operation
- negligent or wanton destruction
- external influences such as fire, water, salts, alkaline solutions, acids, abnormal environmental influences, force majeure
- removal of the product number making it unidentifiable
- mechanical damage through improper transport and fitting
- priming and other surface protection treatment
- repair by non-qualified persons
- using non-Garador parts without the approval of the manufacturer

# Extracts from DHF consumer advice

The following document has been created by the Door and Hardware Federation (DHF) and endorsed by all major UK garage door manufacturers, as a guide for purchasers and domestic garage doors.

## Visual Appearance of Garage Doors

A new garage door can be a significant investment that will transform the appearance of your home. This information is a guide to the quality you can expect.

### The Quality Check

The quality check should be carried out in natural daylight, not direct sunlight. Stand at a distance of 3 metres from the door to view the overall appearance. The door is acceptable if, taking into account the facts below, none of the following are readily visible on the face of the door:

- Marks or distortion associated with the manufacturing process
- Minor indentations, marks or scuffs on the surface
- Paint or stain blemishes

## The Facts

### Steel Doors

- Panel Distortion

The rolling or pressing of steel panels during manufacture will cause distortion in the steel and while every effort is made to keep this to a minimum, inevitably some visible distortion will remain. The application of high gloss paints will make this slight distortion more apparent, especially under certain lighting conditions, such as car headlamps, or bright sunshine.

- Paint Finish

Primed doors – the primer coating is applied as a base coat only and as such requires additional finishing with a good quality exterior paint.

Any marks or scratches on the primer coat should be rubbed down and repainted as part of this finishing process.

Finished doors – the factory application of the paint finish is an automated process and this may result in minor blemishes or slight inconsistencies in the paint, particularly in the area of panel joints.

### Timber Doors

- Timber

Timber is a natural product and there will be variations in pattern, colour, shading and grains. No two doors will be the same. Wood naturally expands and contracts according to environmental conditions, joints will open and close and some minor curvature may occur.

- Finishing

It is vital that timber doors are fully finished as per the manufacturers instructions before exposure to the elements.

### GRP and composite Plastic Doors

- Mould Marks

GRP doors are individually handcrafted in a mould and are then hand finished. Some minor marks and blemishes will inevitably remain after this process.

- Translucency

When viewed from the inside, it is often possible to see variations in the translucency of the door, particularly around and between areas of relief. Such variations do not detract from the overall strength or build quality of the door.

### All Doors

- Colour Match

Pairs of doors should be ordered together to obtain the best colour match, bearing in mind the limitations of the materials used in the construction. Timber garage doors cannot be ordered as matching sets.

- Size Variations

As the size of a door changes in height and/or width, the panel frequency and profile can change, therefore doors of the same style but of different sizes can be significantly different in appearance.

- Clearances

All doors require operating clearances, i.e. the gap between the door panel and the frame opening, these are inbuilt during manufacture and should not be reduced by means of infills, or draughtproofing.

- Deflection

When in the open position, all doors will display a level of vertical deflection or 'sag' across the width of the panel. Individual manufacturers' specifications should be consulted for exact tolerances.



# GARADOR

*The Garage Door People*

Bunford Lane, Yeovil, Somerset, BA20 2GL  
Tel: (01935) 443722 Fax: (01935) 443744

[www.garador.co.uk](http://www.garador.co.uk)



Garador is the UK's leading manufacturer of garage doors and operators, with an ultra-modern production facility located in Somerset. We use German engineering expertise to produce highly sophisticated doors and operators. By purchasing a Garador product you can be assured of the highest level of quality, safety and security. With a nationwide network of stockists, installers and service technicians we are an ideal partner for your project.